

Coexistence Gaps in Space via Interference Nulling for LTE-U/WiFi Coexistence

Suzan Bayhan, Anatolij Zubow, and Adam Wolisz
 Technische Universität Berlin, Germany
 {bayhan, zubow, wolisz}@tkn.tu-berlin.de

Abstract—To avoid the foreseeable spectrum crunch, LTE operators have started to explore the option to directly use the underutilized unlicensed spectrum in 5 GHz UNII bands being mainly used by IEEE 802.11 (WiFi). However, as LTE is not designed with shared spectrum access in mind, it has a potential to seriously harm Wi-Fi. Currently suggested solutions focus on forcing LTE-U to introduce coexistence gaps in either frequency, time, or space domain, and are addressing the coexistence only indirectly due to the lack of coordination among the coexisting WiFi and LTE-U networks. Contrary to these schemes, our proposal introduces explicit cooperation between neighboring LTE-U and WiFi networks. We suggest that LTE-U BSs equipped with multiple antennas can create *coexistence gaps in space domain* in addition to the time domain gaps by means of cross-technology interference nulling towards WiFi nodes in the interference range. In return, LTE-U can increase its own airtime utilization while trading off slightly its antenna diversity. We demonstrate that such cooperation offers benefits to both WiFi and LTE-U in terms of improved throughput and decreased channel access delay. More specifically, system-level simulations reveal a throughput gain up to 221% for LTE-U network and up to 44% for WiFi network depending on the setting, e.g., distance between the two cells, number of LTE antennas, and WiFi nodes in the LTE-U BS neighborhood. Our approach provides significant benefits especially for moderate separation distances between LTE-U/WiFi cells where interference from a neighboring network might be severe due to the hidden network problem.

I. INTRODUCTION

The rapid growth of wireless traffic has been a key challenge for mobile network operators in the past years. Luckily, wireless local area networks (WiFi/IEEE 802.11) have acted as a life ring by carrying a significant fraction of the offloaded mobile traffic (60% in 2015 [1]). Recently, however, LTE operators have started to explore other options, known as *unlicensed LTE*, to use the unlicensed spectrum directly by performing carrier aggregation deep at the radio link level. Aggregation at this level has potential to expand the cellular capacity significantly and enables efficient load balancing over the licensed and unlicensed channels as the LTE network has full awareness of the network load and signal quality of both links [2] and full control over the load shifting. On the other hand, the proliferation of a particular technology like LTE in Unlicensed spectrum (LTE-U [3]) in parallel with the predicted exponential growth in the usage of WiFi is expected to result in severe mutual interference. In case of both these networks operating on the same channel at 5 GHz UNII bands, a significant performance degradation can be expected (e.g., [4], [5]), unless

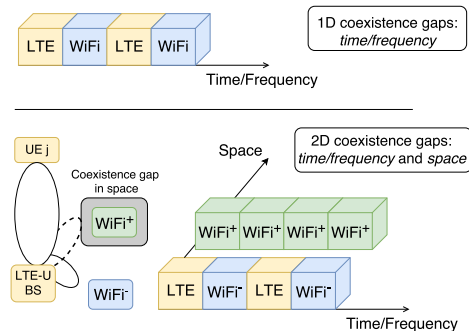

Fig. 1. Coexistence gaps in one dimension either in time or frequency domain (top figure) and proposed coexistence gaps in two dimensions (bottom figure). WiFi⁺ is the WiFi node being nulled and WiFi⁻ receives strong signals from the LTE BS as it is not nulled.

LTE-U networks implement coexistence solutions cautiously. The reason for that is simple: WiFi has high flexibility in the time domain, as it uses the channel in a random access listen-before-talk (LBT) manner with a fine time granularity. This feature assures high efficiency in coexistence of several independent WiFi installations. On the contrary, the LTE-U network follows a predefined schedule, which can be changed only in the time scale in the order of tens of milliseconds, colliding with any other traffic in its activity phases.

Recent years have witnessed a boom of coexistence designs for LTE-U and WiFi, e.g., [6], [7], [8], [9], aiming at improvements of LTE-U coexistence-friendliness towards WiFi (i.e., achieving some air usage fairness) by adapting its operation parameters, e.g., reducing duty-cycle and introducing subframe puncturing, at the expense of performance in the LTE-U network. However, such adaptation can take place only on rather long time scales and fails in assuring flexible coexistence in short term. We argue that flexibility of coexisting networks is key to achieving “joy of the commons” as opposed to well-known issue of “tragedy of the commons” in the unlicensed bands where the networks operate mostly on equal rights.

In this paper, we suggest to add additional flexibility to LTE-U in the space domain as shown in Fig. 1. More specifically, we suggest that LTE-U BSs equipped with an antenna array, should exploit some of its antenna resources to perform interference-nulling towards co-located WiFi nodes and to decrease the impact from its downlink (DL) traffic on these WiFi nodes. In return, LTE-U can increase its own airtime utilization as the nulled WiFi nodes can receive their DL traffic during LTE-U’s on-period without distortion and hence need

not to be considered in airtime fairness considerations (as explained in Sec IV-C). In other words, an LTE-U BS can create coexistence gaps (similar to *almost blank subframes*) in space domain by means of interference nulling. We argue that our proposal smoothly introduces politeness to the LTE-U which is crucial for fair spectrum sharing with WiFi, instead of changing the LTE's nature to introduce LBT functionality.

Our proposal is beyond coexistence: it suggests direct cooperation among WiFi and LTE-U networks, which is necessary for using the unlicensed bands with high efficiency rather than passively implementing coexistence solutions to decrease the impact of one network on the other. Hence, it falls into the family of coordinated coexistence solutions [8]. Although current technologies do not support communication of control messages between LTE-U and WiFi, a recent study, LtFi [10], shows a way to create a cross-technology control channel (CTC) between LTE-U and WiFi for radio resource management. We believe that our approach can be implemented using such a CTC.

Contributions: We propose to apply interference-nulling at the LTE-U BSs equipped with multiple antennas towards co-located co-channel WiFi nodes as a way to create coexistence gaps in space so that LTE-U/WiFi coexistence can be improved. We first present a model capturing the trade-offs between the airtime and the channel rate under a given nulling configuration. Next, we provide an optimization problem formulation to derive the optimal nulling configuration and also present a low-complexity heuristic for finding groups of nodes to be nulled. Simulation results reveal that interference-nulling can improve the throughput of the LTE-U cell up to 221% while also providing some gains for the WiFi, e.g., 44%. Moreover, both systems enjoy lower channel access delay which is of great importance for applications requiring low-latency communication.

II. BACKGROUND ON LTE-U, WiFi, AND NULLING

A. LTE-U

LTE-U is being specified by the LTE-U forum [3] as the first cellular solution using unlicensed bands for DL traffic. The LTE carrier aggregation framework supports utilization of the unlicensed band as a secondary cell in addition to the licensed anchor serving as the primary cell. The LTE-U channel bandwidth is set to 20 MHz which is equal to the smallest channel width in WiFi. The main coexistence mechanism of LTE-U is dynamic channel selection where the LTE-U BS seeks for a clear channel (coexistence gap in frequency domain in Fig. 1). If no such channel is identified, LTE-U selects the channel with the least observed WiFi utilization and applies duty-cycling in this channel. As LTE-U does not implement LBT, it can be deployed only in countries where LBT is not mandated for unlicensed channel access, e.g., USA and China.

Fig. 2 illustrates the duty cycled unlicensed channel access of LTE-U. An LTE-U BS actively observes the channel for WiFi transmissions and estimates channel activity for dynamic

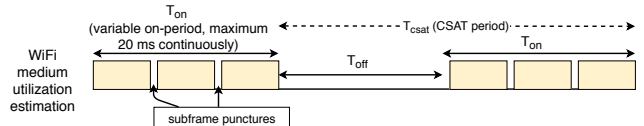

Fig. 2. Adaptive duty cycling in LTE-U.

channel selection and adaptive duty cycling. A mechanism called *carrier sense adaptive transmission* (CSAT) is used to adapt LTE-U's duty cycle [11], [12], i.e., by modifying the on-period (T_{on}) and off-period (T_{off}) values, to achieve fair sharing. Moreover, LTE-U transmissions contain frequent gaps, so called *subframe punctures*, in the on-period, which allow WiFi to transmit delay-sensitive data. Qualcomm [12] recommends 40, 80, or 160 ms as LTE-U period and at least 2 ms puncturing gaps every 20 ms. Note that LTE-U does not apply LBT before packet transmission in the on-period.

B. WiFi

In contrast to LTE-U which uses scheduled channel access, WiFi nodes (APs as well as STAs) perform random channel access using an LBT scheme, i.e., CSMA. WiFi makes use of both virtual and physical carrier sensing. Because WiFi is unable to decode LTE-U packets, it has to rely on physical carrier sensing (CS). Moreover, CS is restricted to Energy Detection (ED) which is less sensitive compared to preamble-based CS methods: ED threshold for sensing an LTE-U signal is -62 dBm whereas a WiFi AP can detect other WiFi signals at the sensitivity level around -82 dBm.¹ ED threshold for LTE-U to sense WiFi signals is -82 dBm which is recently agreed by the WiFi Alliance's Coexistence Test Plan [14].

An LTE-U's transmission may have the following two impacts on WiFi depending on the received LTE-U signal's strength: (i) WiFi cannot access the medium during LTE-U's on-periods as ED mechanism of WiFi is triggered at the WiFi transmitter; (ii) WiFi experiences frequent packet corruptions due to co-channel interference at the WiFi receiver. Case (i) results in lower airtime for WiFi due to channel contention while Case (ii) results in wasted airtime due to packet loss caused by inter-technology hidden node problem [4], [5].

C. Interference Nulling

A transmitter equipped with an antenna array, e.g., uniform linear array (ULA), can use precoding to change how its signal is received at a particular wireless node. To do so, it multiplies the transmitted signal by a precoding matrix P . Specifically, in interference nulling the precoding matrix is chosen to null (i.e., cancel) the signal at a particular receiver, i.e. $HP = 0$, where H is the channel matrix from transmitter to receiver [15]. Note that the transmitter requires knowledge of H .

III. SYSTEM MODEL

We consider a coexistence scenario as in Fig. 3 where an LTE-U cell and WiFi Basic Service Set (BSS) have overlapping coverage and share the same unlicensed channel for their

¹There is some debate on whether WiFi's ED threshold is fair and a suggestion to change WiFi's ED level from -62 dBm to -72 dBm [13].

operation.² The LTE-U BS and the WiFi AP is separated by a distance of D meters.

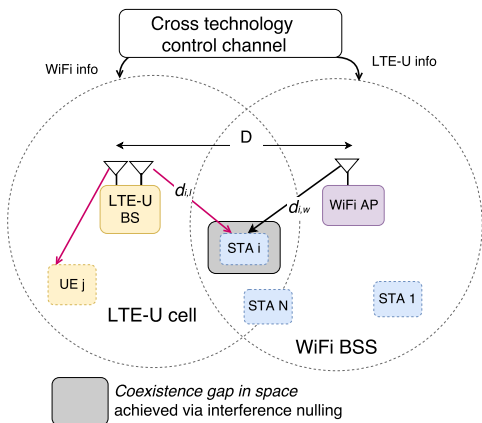

Fig. 3. Considered coordinated LTE-U and WiFi coexistence setting.

Denote the set of UEs served by the LTE-U BS by $\mathcal{U}^l = \{u_1^l, \dots, u_M^l\}$. Similarly, denote the set of stations served by the WiFi AP by $\mathcal{U}^w = \{u_1^w, \dots, u_N^w\}$. For the simplicity of the notations, we use index 0 for the WiFi AP (u_0^w) and LTE-U BS (u_0^l). Let $d_{i,x}$ and $\theta_{i,x}$ denote the distance and angle of a user i (be it a UE or STA) from a BS x ($x = l$ for LTE-U or w for WiFi AP), respectively. We assume that LTE-U BS serves its UEs in different time slots, i.e. TDMA based scheduling.

We consider backlogged traffic for both networks and focus on the DL only. For LTE-U system, this corresponds to supplementary DL case. For WiFi, our scenario is still relevant as current networks are DL-heavy, e.g., 80-90% [16] of data traffic is attributed to DL.

LTE-U BS detects the WiFi nodes if it receives the WiFi signals above the ED threshold for the WiFi signals, Γ_w dBm. Similarly, a WiFi AP detects the existence of an LTE-U BS in its neighborhood if the AP receives an LTE-U signal above ED threshold Γ_l dBm. Note that Γ_w and Γ_l do not need to be equal. We denote the bandwidth of an unlicensed channel by B . Transmission power of LTE-U and WiFi is denoted by P_l and P_w . The distance-dependent pathloss parameter γ is assumed to be identical as both networks are deployed in the same environment and operate at the same frequency.

We assume that LTE BS is equipped with an antenna array of K antennas (uniform linear array, ULA) whereas all its users and all WiFi nodes (i.e., AP as well) have only single antenna. The LTE BS is able to precode its DL signal for the purpose of beamforming and interference-nulling toward its own UEs as well as a subset of the WiFi nodes to cancel out its interference on these users. Moreover, we assume the existence of a Cross-Technology Control (CTC) channel between LTE-U BS and WiFi AP, e.g., LtFi [10], which is used for exchanging signalling and control data needed for interference nulling. Moreover, it is used for proximity

²An extension to multiple cells is straightforward in case LTE cells are synchronized in their CSAT cycles. We plan a multicell setting as future work.

detection, i.e., gives information about the pair of nodes, LTE and WiFi, in mutual interference range. To compute the precoding matrix for interference-nulling, the LTE-U BS requires knowledge of the channel matrix H towards the WiFi nodes (refer Section II-C). We assume that the LTE-U BS acquires the CSI H from the control channel.³

We define the WiFi nodes being nulled by the LTE-U BS as \mathcal{U}_\emptyset^w and their number by K_\emptyset , i.e., $|\mathcal{U}_\emptyset^w| = K_\emptyset$. Denote the LTE-U BS's beam and nulling configuration $(\theta, \mathcal{U}_\emptyset^w)$ where θ is the angle between the LTE-U BS and its UE that is being served at this timeslot. Based on the beamforming/nulling algorithm applied, we can calculate the gain at each user. Let us denote the beamforming gain at the receiver under a configuration $(\theta, \mathcal{U}_\emptyset^w)$ by Φ and Φ_i is the gain at UE u_i . Note that a WiFi station being nulled, e.g., u_i^w , will have a very small Φ_i value representing the fact that an efficient nulling algorithm results in very weak LTE-U signal at this user. Under perfect nulling, Φ_i approaches to zero.

IV. OPTIMAL INTERFERENCE-NULLING AND BEAMFORMING IN THE LTE-U DL

A. Overview

As LTE-U does not implement LBT, it has to rely on duty-cycling which is adapted according to the observed WiFi medium utilization and number of WiFi nodes. Briefly, LTE-U must leave the medium for WiFi proportional to the number of WiFi nodes observed in the neighborhood. That means, LTE-U's airtime is lower in case of high number of WiFi nodes in the ED range of the LTE-U BS. Given this key fact as our ground, an LTE-U BS can look for ways to decrease number of WiFi nodes that will be affected by the interference of the LTE-U transmission, i.e., WiFi nodes in its ED range. This can be achieved in several ways, e.g., decreasing the LTE-U BS transmit power [9] or switching some WiFi users equipped with dual radio to the LTE cell [18]. Our approach is different as defined in the following.

We apply cross-technology interference-nulling from LTE-U BS towards carefully-selected WiFi nodes. As a result, these nulled WiFi nodes receive only very weak interference from the LTE-U DL. Hence, from the perspective of the WiFi node, the LTE-U BS is no longer in the competition for the shared medium. As a consequence, there is no need to consider such nodes in the estimation of the fair airtime share at the LTE-U BS. Therefore, LTE-U can maintain a larger share of airtime compared to the case where there is no interference-nulling. Moreover, since these nulled WiFi nodes are able to receive interference-free traffic during LTE-U's on-period, this approach promises benefits also to the WiFi network. On the other hand, longer airtime is achieved at the expense of reserving some of the LTE-U BS's antennas for interference-nulling rather than using them for LTE-U's own DL transmission. In other words, some of the LTE-U BS's antenna diversity (aka degree of freedom) is sacrificed for longer

³In a practical setting, it is challenging to acquire H . Please see [17] for more details on how we tackle the lack of CSI at the LTE-U BS in a different way and implement interference nulling on commodity hardware.

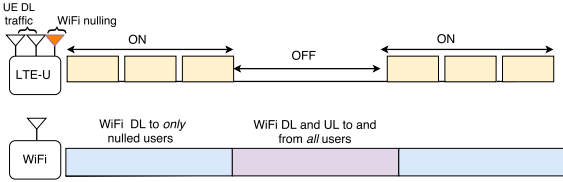

Fig. 4. Medium access of the LTE-U BS and WiFi nodes.

airtime usage. Hence, LTE-U BS needs to apply interference-nulling cautiously, i.e., we need to find the optimal operation point where both networks will be better off.

There are several questions we must address in deriving the optimal operation point: (i) How many of the degrees of freedom, i.e., antennas, an LTE-U BS should use for interference-nulling? (ii) Which of the co-located WiFi nodes (APs and STAs) should be nulled? To address the above-listed nontrivial questions, we derive the trade-off between the additional airtime LTE-U gains from interference-nulling and the performance degradation in the LTE-U cell due to the reduced number of degrees of freedom. For the first question, we need to formulate the LTE-U throughput considering the airtime as well as the SNR at the UE before and after nulling. Regarding the second question, the network geometry, i.e. the locations of the co-located WiFi nodes, need to be considered, e.g., their distances from the interfering nodes and the serving node (LTE-U BS or WiFi AP).

Our aim is to find the beamforming/nulling configuration for the LTE-U BS that provides a good balance between the LTE-U and WiFi throughput, which is crucial to achieve a harmonious coexistence in the considered unlicensed bands. As throughput is a function of the airtime available to a system and the average rate when the considered system captures the medium, we explain next how to calculate the airtime and DL rate of LTE-U and WiFi systems under a particular beamforming/nulling configuration $(\theta, \mathcal{U}_{\emptyset}^w)$. Then, we formulate the problem as a sum-rate maximization problem subject to constraints of the nulling and WiFi-LTE-U coexistence setting.

B. Medium Access under Nulling

Consider a case where all nodes are in a single collision domain. Since we consider only the DL, WiFi AP and LTE-U BS are the candidate transmitters who need to apply time sharing. In case LTE-U BS nulls the WiFi stations (receivers of WiFi DL traffic), it achieves a higher airtime resulting in lower airtime for the WiFi network. However, as WiFi AP defers during LTE-U on-periods, it will not be able to transmit to the nulled WiFi stations in the DL. Hence, in this case, the WiFi will not benefit from nulling. However, LTE-U BS can choose to put a null also in the direction of the WiFi AP. Then, WiFi AP can transmit all the time and may achieve good channel rate at the nulled stations. Nulling only the WiFi stations can improve the WiFi performance in case the WiFi AP is sufficiently far away from the LTE-U BS such that it does not sense the LTE-U BS but WiFi stations are closer to the LTE-U BS. Hence, WiFi DL traffic will benefit from the absence of co-channel interference. Nulling is especially beneficial in case

of cross-technology hidden-terminal problem. In this case, the WiFi AP can send DL traffic to the nulled stations during LTE-U's on-period without LTE interference.

Fig. 4 shows the medium access in these two considered cases. While WiFi transmission in both uplink (UL) and DL could be possible during the LTE-U on-period, it is impossible for LTE-U BS to predict which WiFi node will transmit due to the random access nature of WiFi. Hence, from a practical viewpoint, we need a solution where the nulling configuration does not depend on the WiFi traffic but rather only on the positions of the WiFi nodes. We suggest to focus on the WiFi DL which is meaningful as it represents the lion share of the traffic in the WiFi cell. Therefore, during the LTE-U's on-period, only WiFi DL traffic is considered and any WiFi UL traffic might experience high co-channel interference from LTE-U in case the WiFi AP is not being nulled.⁴

C. Airtime under Nulling

Airtime is the fraction of time a node can access the medium. Let us denote by α_l and α_w the LTE-U airtime and WiFi airtime. Since we consider DL, there is only one transmitter at each network, i.e., LTE-U BS and WiFi AP, we can safely use the term LTE-U airtime or WiFi airtime to refer to the airtime of the LTE-U BS and WiFi AP, respectively.

To calculate airtime at each system, we first check if the respective transmitter, BS or AP, senses the other transmitter. Let σ_w represent whether WiFi AP receives the LTE-U BS signal above the predetermined ED level under a beam configuration Φ . Recall that WiFi and LTE-U may apply different ED thresholds for signal detection. We define σ_w as follows:

$$\sigma_w = \begin{cases} 1 & , \frac{P_l D^{-\gamma} \Phi_0}{B\eta_0} \geq \Gamma_l \\ 0 & , \text{otherwise.} \end{cases} \quad (1)$$

In (1), we include the term Φ_0 to represent the resulting LTE-U BS's antenna gain at the AP under Φ , i.e., precoding.

In case $\sigma_w = 0$, WiFi's airtime is 1 meaning that it accesses the medium all the time since from its perspective there is no other transmission in the channel requiring it to defer from the channel. On the other hand, for $\sigma_w = 1$, since WiFi applies CSMA-based medium access, the available airtime for WiFi depends on the time the LTE-U does not use the medium, i.e., off-periods. Hence, we need to first calculate LTE-U's airtime.

LTE-U applies CSAT as the main coexistence scheme. Based on the CSAT *on* and *off* periods, we can calculate the airtime for LTE-U simply as $\alpha_l = \frac{T_{on}}{T_{csat}}$ where $T_{csat} = T_{on} + T_{off}$ is the CSAT cycle set to a predefined recommended value, e.g., 80 ms [11]. While there are different suggestions to adapt the CSAT *on* duration (hence the T_{off} duration as $T_{csat} - T_{on}$), we will consider the approach suggested in [11] which adapts T_{on} in several iterations according to the medium utilization of WiFi.

⁴This will surely create a problem for control frames like immediate ACKs. We recommend to use delayed block ACKs available since IEEE 802.11n. These frames are sent via contention-based access and therefore can be postponed to the off-period where all types of traffic is possible.

Let us now overview the proposal in [11]. LTE-U small cells are scheduled to sense for WiFi packets during monitoring slots (in CSAT off-period) and estimate the medium utilization (MU) according to the decoded packet type and its duration. Given that off-period is sufficiently long, LTE-U cells may perform medium sensing several times and have a better observation about the ongoing WiFi traffic activity. In our model, we assume backlogged DL for both networks. Hence, WiFi's medium utilization converges to 1.

An MU value higher than a threshold, e.g., MU_1 , triggers LTE-U BS to decrease its T_{on} as follows:

$$T_{on} = \max(T_{on} - \Delta T_{down}, T_{on,min}), \quad (2)$$

where T_{down} is the granularity of decrease at each adaptation step and $T_{on,min}$ is the minimum duration for on-period to ensure that LTE-U BS can transmit for some minimum duration. This minimum duration is computed according to the number of WiFi nodes being detected from the preambles of WiFi packets sensed by the LTE-U BS such that the airtime available to each system is *fair*.

Let N_{cs} denote the number of WiFi nodes whose received signal level is above the carrier sense threshold at the LTE-U BS. We can calculate N_{cs} as follows. With a slight abuse of the notation, we denote by $\sigma_{l,i}$ the flag taking value 1 if LTE-U BS senses WiFi user u_i^w .

$$\sigma_{l,i} = \begin{cases} 1 & , \frac{P_{w,i} d_{i,l}^{-\gamma}}{B\eta_0} \geq \Gamma_w \\ 0 & , \text{otherwise} \end{cases}$$

where $P_{w,i}$ is the transmission power of u_i^w . Consequently, we can compute N_{cs} as: $N_{cs} = \sum_{i=0}^N \sigma_{l,i}$. After calculating N_{cs} , LTE-U can compute $T_{on,min}$ as:

$$T_{on,min} = \min(T_{min}, \frac{(M_{same} + 1)T_{csat}}{M_{same} + 1 + M_{other} + N_{cs}}), \quad (3)$$

where T_{min} is a configuration parameter tuning the minimum duty cycle below ED, M_{same} is the number of detected LTE-U small cells of the same operator, and M_{other} is the number of detected small cells of other operators. Note that LTE-U small cells belonging to the same operator have the same public land mobile network ID. In the above equation, setting $M_{same} = 0$ and $M_{other} = 0$, we calculate the second term of (3) as $\frac{T_{csat}}{N_{cs}+1}$. As a smart decision from the perspective of LTE-U is to set T_{min} larger than $\frac{T_{csat}}{N_{cs}+1}$, we can articulate that $T_{on,min}$ is determined by the second term of (3). Hence, we assume that $T_{on,min} = \frac{T_{csat}}{N_{cs}+1}$.

At each iteration of CSAT adaptation, LTE-U BS will be forced to decrease its on duration by T_{down} as in (2) since AP has always DL traffic, i.e., $MU \geq MU_1$. Consequently, T_{on} converges to $T_{on,min}$ which is calculated as $\frac{T_{csat}}{N_{cs}+1}$. Finally, we calculate the LTE-U airtime in case of no nulling as:

$$\alpha_l(K_\emptyset = 0) = \frac{T_{csat}}{T_{csat}} = \frac{1}{N_{cs} + 1}. \quad (4)$$

If K_\emptyset users are nulled, the LTE-U airtime becomes:

$$\alpha_l(K_\emptyset) = \frac{1}{(N_{cs} - K_\emptyset) + 1}. \quad (5)$$

In the above formula, nulled nodes are neglected while calculating the airtime as they will only marginally be affected by an LTE-U signal under an efficient null steering scheme. Therefore, they become irrelevant in fairness consideration.

Now, for $\sigma_w = 1$, we can calculate WiFi airtime based on whether LTE-U BS nulls the AP or not. In case WiFi AP is nulled, the WiFi airtime equals to 1. That is, interference nulling at the WiFi AP results in WiFi AP never defer as it will never sense an ongoing LTE-U transmission. If LTE-U does not prefer to null the AP, WiFi airtime is $\alpha_w = 1 - \alpha_l(K_\emptyset)$.

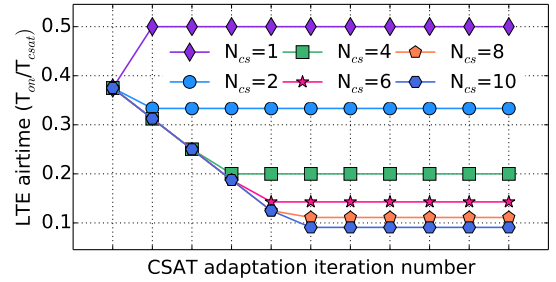

(a) LTE-U airtime for various N_{cs} .

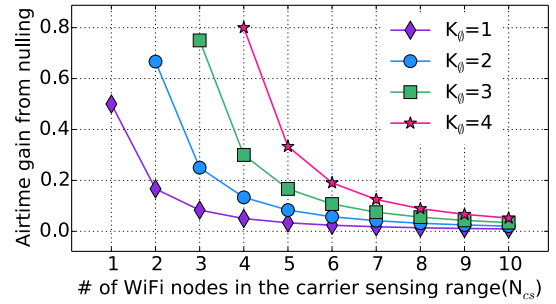

(b) Nulling gain with increasing N_{cs} for various K_0 .

Fig. 5. Impact of CSAT adaptation and nulling on LTE-U airtime.

Table I summarizes airtime values based on carrier sensing condition of each network, $CSR(\sigma_w, \sigma_l)$ where $\sigma_l = \{0, 1\}$ and $\sigma_w = \{0, 1\}$. Note that we have the same airtime formula for the LTE-U independent of its σ_l value as there may be cases where LTE-U does not hear the transmission of the AP but overhears those of the stations. That is to say, what really matters for LTE-U is the number of WiFi nodes in the ED range of the LTE-U BS. For WiFi, we must consider σ_w as well as the nulling status of the AP.

Implementing the algorithm of [11], we find the change in LTE-U airtime at each CSAT adaptation step with increasing N_{cs} under the assumption that medium utilization is 1, i.e., WiFi traffic is backlogged. We set the initial values of $T_{on}=40$ ms, $T_{off}=40$ ms, $T_{csat}=80$ ms, $\Delta T_{down}=5$ ms. Moreover, we set $T_{on,min}=80$ ms to let LTE-U be constrained by the WiFi traffic not artificially by its misconfiguration. Fig.5a plots the LTE-U airtime, i.e., $\alpha_l = \frac{T_{on}}{T_{csat}}$, for various number of neighboring WiFi nodes. Notice that the airtime values converge to $\frac{1}{N_{cs}+1}$ after some adaptation steps as expected from our analysis. The convergence speed obviously depends on the initial value of T_{on} as well as T_{csat} , number of WiFi

TABLE I

AIRTIME OF LTE-U AND WiFi FOR VARIOUS CSR(σ_w, σ_l) SCENARIOS: $\sigma_x = 1$ MEANS THAT NETWORK $X = \{l, w\}$ SENSES THE OTHER NETWORK ABOVE THE ED LEVEL. SHADED CELL CORRESPONDS TO THE AIRTIME FOR WiFi WHEN NULLING IS NOT APPLIED.

Nw.	CSR(0,0)	CSR(0,1)	CSR(1,0)	CSR(1,1)		
				Null AP	Null K_\emptyset STAs	No Null
WiFi AP	1	1	$1 - \frac{1}{N_{cs} - K_\emptyset + 1}$	1	$1 - \frac{1}{N_{cs} - K_\emptyset + 1}$	$1 - \frac{1}{N_{cs} + 1}$
LTE-U BS	$\frac{1}{N_{cs} - K_\emptyset + 1}$					

stations in the coexistence domain (N_{cs}) and how successfully LTE-U can detect their existence (MU and N_{cs}), and the granularity of decrease/increase steps ($\Delta T_{down}, \Delta T_{up}$). From Fig.5a, we can also observe the nulling gain as the difference between the curves corresponding two different N_{cs} curves. For example, for the initial setting of $N_{cs}=10$, we will get the nulling gain in terms of airtime under $K_\emptyset=2$ as much as the difference of airtimes for $N_{cs}=8$ and that of $N_{cs}=10$, i.e., $1/9 - 1/11$. For lower N_{cs} , the benefit of nulling is more pronounced as seen in Fig.5b which plots the gain in the LTE-U airtime by nulling K_\emptyset WiFi nodes under different N_{cs} values.

D. Throughput under nulling

Let us consider an LTE-U UE and calculate its throughput in the DL. For the LTE-U UE u_j^l , DL rate can be defined as:

$$r_{j,l} = \begin{cases} r_{j,l}^0 = B \log\left(1 + \frac{P_l d_{j,l}^{-\gamma} \Phi_j}{B\eta_0}\right), & \text{blocked WiFi AP} \\ r_{j,l}^1 = B \log\left(1 + \frac{P_l d_{j,l}^{-\gamma} \Phi_j}{B\eta_0 + P_w d_{j,w}^{-\gamma}}\right), & \text{unblocked WiFi AP} \end{cases}$$

where WiFi AP may be unblocked in two cases: (i) the AP does not sense LTE-U BS, i.e., $\sigma_w = 0$, or (ii) despite $\sigma_w = 1$, the AP can transmit because it is nulled. Note that in the above equation Φ_j is a function of the number of antennas used for nulling. The LTE-U BS uses its $(K - K_\emptyset)$ antennas for this UE resulting in lower beam gain if less antennas are available for the UE. As we already calculated the airtime for LTE, we can find the throughput for an LTE UE as: $R_{j,l} = \alpha_l r_{j,l}$.

As for WiFi DL rate, we need to consider whether coexistence is only in the time domain or in both time and space domains. For the former, there will be no LTE-U BS interference on the WiFi DL. However, for the latter, as LTE-U BS changes state between on and off periods while WiFi AP has DL traffic, we calculate the WiFi DL rate at WiFi station u_i^w considering the rates during on and off periods. Let us consider the first case, i.e., $\sigma_w = 1$ and AP is not nulled. WiFi throughput in this case $R_{i,w}^0$ equals to:

$$R_{i,w}^0 = (1 - \alpha_l) B \log\left(1 + \frac{P_w d_{i,w}^{-\gamma}}{B\eta_0}\right). \quad (6)$$

If sharing is in time and space, i.e., $\sigma_w = 0$ or AP is nulled, WiFi throughput $R_{i,w}^1$ equals to:

$$\underbrace{\alpha_l B \log\left(1 + \frac{P_w d_{i,w}^{-\gamma}}{B\eta_0 + P_l d_{i,l}^{-\gamma} \Phi_i}\right)}_{\text{LTE on-period}} + \underbrace{(1 - \alpha_l) B \log\left(1 + \frac{P_w d_{i,w}^{-\gamma}}{B\eta_0}\right)}_{\text{LTE off-period}}.$$

Note that if u_i^w is in U_\emptyset^w , Φ_i is marginal and effectively results in no rate degradation in the WiFi DL for u_i^w .

E. Channel access delay under nulling

Let us now calculate the expected time to access the medium for both LTE-U BS and the WiFi AP considering the case of CSR($\sigma_w = 1, \sigma_l = 1$). In a conventional LTE-U/WiFi setting, the LTE-U BS has to wait for the on-period to be able to send its packets while WiFi AP waits for the LTE-U off-period. In this case, expected channel access delay for LTE-U BS τ_l is:

$$\tau_l = (1 - \alpha_l) \frac{T_{off}}{2} = (1 - \alpha_l) \frac{(1 - \alpha_l) T_{csat}}{2} = \frac{(1 - \alpha_l)^2 T_{csat}}{2}$$

Similarly, we calculate the expected channel access delay for WiFi AP τ_w as⁵:

$$\tau_w = \alpha_l \frac{T_{on}}{2} = \alpha_l \frac{\alpha_l T_{csat}}{2} = \frac{\alpha_l^2 T_{csat}}{2}.$$

Under nulling, LTE-U BS experiences a faster access to the channel as LTE airtime α_l is increased. For WiFi, channel access delay gets shorter if AP is nulled: essentially we move from the regime of CSR(1,1) to that of CSR(0,1). As a result, channel access delay becomes zero for the WiFi AP.

F. Problem Formulation

Our aim is to find the nulling configuration to be used at the LTE-U BS that provides the *optimal* performance. We can define different optimization objectives by changing the priority of LTE-U and WiFi denoted by β_l and β_w and satisfying the condition that $\beta_l + \beta_w = 1$. Our policies are: **MaxSum** maximizes the system wide capacity giving each system equal weight, i.e., $\beta_l = \beta_w$, with a constraint that WiFi capacity does not degrade compared to the baseline in which LTE-U does not apply nulling (referred to as NoNull). **MaxLTE** maximizes LTE-U's capacity, i.e., $\beta_l=1, \beta_w=0$. **MaxWiFi** maximizes WiFi's capacity, i.e., $\beta_w=1, \beta_l=0$.

Let $\mathbf{x} = [x_0, \dots, x_N]$ denote the LTE-U BS's nulling configuration where x_i yields value 1 if WiFi station i is nulled,

⁵Note that we neglect the subframe punctures in this calculation considering LTE-U on periods shorter than 20 ms.

0 otherwise. Next, we formulate our problem as follows:

$$\max \quad \beta_w \frac{\sum_{i=1}^N R_{i,w}}{N} + \beta_l \alpha_l \sum_{j=1}^M r_{j,l} \quad (7)$$

$$R_{i,w} = \sigma_w ((1-x_0)R_{i,w}^0 + x_0 R_{i,w}^1) + (1-\sigma_w)R_{i,w}^1, \forall i \quad (8)$$

$$r_{j,l} = y_j (x_0 r_{j,l}^1 + (1-x_0)(\sigma_w r_{j,l}^0 + (1-\sigma_w)r_{j,l}^1)), \forall j \quad (9)$$

$$\sum_{j=1}^M y_j = 1 \quad (10)$$

$$x_i \leq \sigma_{l,i}, \quad \forall i = [0, N] \quad (11)$$

$$\sum_{i=0}^N x_i < K \quad (12)$$

$$\alpha_l = \frac{1}{\sum_{i=0}^N \sigma_{l,i} - \sum_{i=0}^N x_i + 1} \quad (13)$$

$$\alpha_w = x_0 + (1-x_0)(\sigma_w(1-\alpha_l) + (1-\sigma_w)) \quad (14)$$

$$x_i \in \{0, 1\} \quad \forall i = [1, N] \quad (15)$$

$$y_j \in \{0, 1\} \quad \forall j = [1, M] \quad (16)$$

The first term of our objective (7) represents the expected DL throughput of the WiFi network weighted by β_w and the second term stands for the throughput of the LTE network weighted by β_l . Consts.(8) and (9) correspond to the throughput of a WiFi user and rate of an LTE-U user, respectively. Binary variable y_j in Const.(9) represents whether UE j is scheduled to receive DL traffic. Const.(10) states the fact that there is only one UE actively receiving DL traffic from the LTE-U BS at any scheduling period. Since airtime increase is only relevant for nodes that are in the ED range of the LTE-U BS, we add Constr.(11) to ensure that x_i is zero if u_i^w is not in the range of LTE-U BS. Such WiFi nodes are not selected for nulling due to Const.(11). Const.(12) states that maximum number of nulled WiFi nodes must be smaller than the total number of LTE-U antennas so that at least one antenna is reserved for its UE. Consts.(13) and (14) define the airtimes of LTE-U and WiFi, respectively. Note that x_0 in Const.(14) stands for WiFi AP and states the fact that if WiFi AP is nulled, the airtime for WiFi will be 1. Finally, Consts.(15) and (16) denote the type of variables as binary integers.

This problem can be solved for both $\mathbf{x}=[x_i]$ and $\mathbf{y}=[y_j]$ simultaneously or it can be solved for \mathbf{x} after setting \mathbf{y} . Here, we take \mathbf{y} as given, i.e., LTE-U BS first decides on which UE to serve. As solving for \mathbf{x} exactly is of high complexity, we present a low-complexity algorithm which can be implemented easily and run at every duty-cycle period of the LTE-U BS.

V. LOW-COMPLEXITY NULLING: GREEDY

Randomly selecting the nodes, i.e., AP or stations, to be nulled by the LTE-U BS is suboptimal as it may either degrade the wanted signal at the UE, i.e., in case the WiFi node to be nulled and the LTE-U UE cannot be separated in angular domain (or two channels are correlated), or nulling a WiFi transmitter may result in hidden terminal problem as WiFi node's CS mechanism is effectively switched off due

to nulling. To avoid such cases, we propose a null grouping algorithm that groups WiFi nodes into suitable subsets that are beneficial to null.

Our proposed heuristic GREEDY constructs a null group starting with the WiFi node that when being nulled gives the highest gain in terms of the selected metric, e.g., increase in LTE-U capacity, and sequentially extending this group by admitting the WiFi node providing the highest increase of a given grouping metric (refer to three policies in Section IV-F). Once the group reaches its target size, or no more WiFi nodes can increase the grouping metric, the nulling group is considered complete. GREEDY needs following information to compute the metric: i) the set of WiFi nodes in the sensing range of the LTE-U BS, ii) the average pathloss of the channel from WiFi AP towards LTE-UE currently being served. The associated computational complexity considering execution time is $\mathcal{O}((N+1)^2)$ where $N+1$ corresponds to the number of WiFi nodes—AP and STAs.

VI. PERFORMANCE EVALUATION

We evaluate our approach in our Python simulator while computing the antenna array response after precoding (beamforming/nulling) in Matlab's Phased Array system toolbox.⁶ Specifically, we derive the precoding vector using LCMV beamformer [19] as it allows us to put the signal in the desired UE direction while putting nulls toward the selected WiFi nodes. Unless otherwise stated, we use the following parameters: number of UEs $M=1$, $P_l=17$ dBm, $P_w=17$ dBm as well as the power of WiFi stations while calculating N_{cs} , $\Gamma_w=-82$ dBm, $\Gamma_l=-72$ dBm. To determine the location of each user, we randomly select an angle in $[0, 2\pi]$ and distance in $[0, r]$ where r is set to 50 m for both LTE and WiFi. We change D in $[10\text{m}, 130\text{m}]$ with a step of 20 m to cover all interference regimes. Next, we present the average statistics and the standard error of the mean values of 500 runs.

A. Gain from Nulling

This section shows how much gain both LTE-U and WiFi network achieves through nulling with GREEDY under Max-Sum policy. We also compare GREEDY with the optimal solution (OptMaxSum) maximizing the sum of LTE-U and WiFi throughput found through exhaustive search of all possible nulling groups considering the objective function in (7).

Fig. 6 compares NoNull with the proposed nulling scheme for different distances between the LTE-U BS and WiFi AP for $K=6$ and $N=8$. As Fig. 6a depicts, LTE-U cell maintains higher throughput under nulling compared to NoNull. The throughput increase is mostly due to the increased LTE-U duty cycle because of nulling. The performance increase achieved by OptMaxSum is up to 152% for LTE which is realized at $D=50$ m. GREEDY achieves up to 92% improvement over NoNull and the highest gain is realized at $D=30$ m. The second observation is that the difference between GREEDY and OptMaxSum is mostly low with the exception at $D=50$ m.

⁶<https://de.mathworks.com/products/phased-array.html>

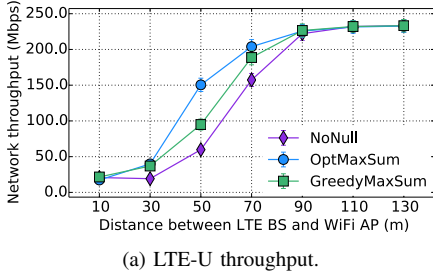

(a) LTE-U throughput.

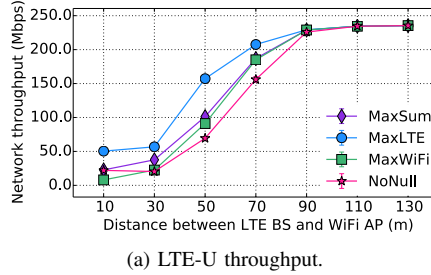

(a) LTE-U throughput.

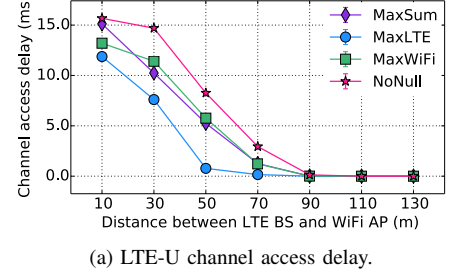

(a) LTE-U channel access delay.

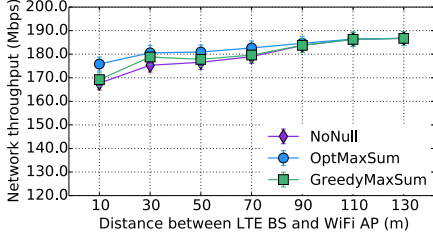

(b) WiFi throughput.

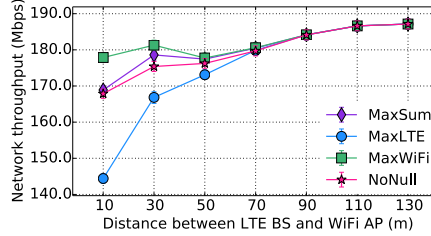

(b) WiFi throughput.

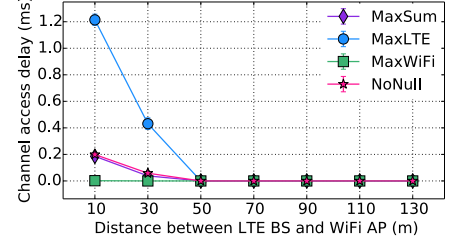

(b) WiFi channel access delay.

Fig. 6. Comparison of schemes for $K=6$, $N=8$.Fig. 7. Optimization objectives, $K=6$, $N=8$.Fig. 8. Channel access delays, $K=6$, $N=8$.

As of WiFi performance, we observe in Fig. 6b that WiFi cell slightly benefits from nulling. At $D=10$ m, the WiFi throughput is increased by 5% (and 1% by GREEDY) which corresponds to the highest gain for WiFi. However, for sparse user deployments, achieved throughput gain is higher. For example, for a WiFi cell with a single station (not plotted), OptMaxSum provides 44% increase to the WiFi cell at $D=10$ m and 19% increase at $D=30$ m. Corresponding gain for GREEDY is 10% and 13%. For high distance, e.g., $D > 90$ m, there is no need for nulling as both networks mutual interference approach to zero.

B. Impact of optimization objective

Fig. 7 shows each network's throughput achieved by GREEDY under each nulling policy. We see that MaxSum offers a very good balance between LTE-U and WiFi performances: it achieves nonnegative gains at each network while other two objective might result in one network to suffer. Fig. 8 shows a similar trend considering the channel access delay of each network for LTE-U $T_{csat}=40$ ms. In Fig.8a, we also observe the reduction in the channel access latency at the LTE-U BS facilitated by nulling. For WiFi AP, channel access is faster than that of LTE-U BS due to longer airtime of the WiFi cell for this setting with $N=8$. Nevertheless, MaxWiFi can decrease it even further toward zero. However, considering the LTE-U network's performance, we pick MaxSum as our policy for GREEDY in the following analysis.

C. Impact of number of LTE-U BS antennas

Fig. 9 shows the impact of the number of LTE BS antennas when the neighboring WiFi cell has 8 stations. Here, we present the absolute throughput gain of the proposed scheme over NoNull. Unsurprisingly, we observe in Fig. 9a that the LTE-U throughput can be increased significantly with larger number of antennas. This improvement is due

to both increased beamforming gain and the possibility to steer multiple nulls. With increasing D , we first observe an increasing throughput gain. In this region, the increase in airtime due to more nulls outweighs the sacrificed antenna diversity at the LTE-U cell. As we observed also in Fig. 9a, with further increase in distance, the need for interference nulling diminishes resulting in no throughput gain. For example, for $K=10$, achieved gains are (26%, 221%, 61%, 20%, 1%) for $D=(10, 30, 50, 70, 90)$ m.

From WiFi's perspective, we observe a similar trend in Fig. 9b. It has throughput gain in all cases for $D < 90$ m but the gain is markedly lower compared to the LTE-U's gain. In Fig. 10, we show for $D=30$ m the airtime and SNR under NoNull and GREEDY for both LTE and WiFi. The figure shows that the airtime increase in LTE is very significant whereas there is also some decrease in the average SNR due to the loss in antenna diversity. On the contrary, WiFi experiences almost no change in its SNR and airtime.

D. Impact of number of WiFi users

Fig 11 shows the throughput gain of GREEDY over NoNull with $K=6$ antennas at the LTE-U BS for various number of users N and under increasing distance D . Regarding LTE-U cell, for short D , Fig. 11a shows that nulling brings higher throughput gain for N . In this region, WiFi AP senses the LTE-U BS. The only way to offer performance improvement also to the WiFi is to null the WiFi AP. However, WiFi stations, especially the ones in the near proximity of the LTE-U BS, must also be nulled to facilitate interference-free DL traffic at these stations. If LTE-U BS has enough antennas to null all the nearby stations, the WiFi network will boost its throughput as if there is no coexisting LTE-U network (as observed in Fig.11b). Otherwise, i.e., case of many WiFi users, LTE-U may prefer putting coexistence gaps only in the time

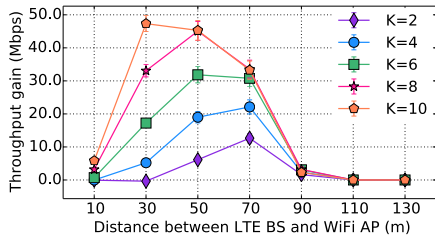

(a) LTE-U throughput gain.

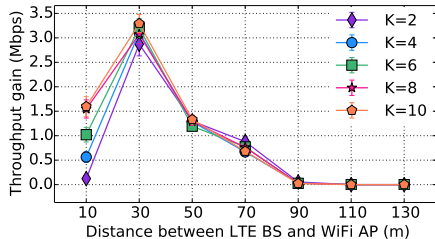

(b) WiFi throughput gain.

Fig. 9. Change in the throughput gain over NoNull under various LTE-U BS antenna settings, $N = 8$.

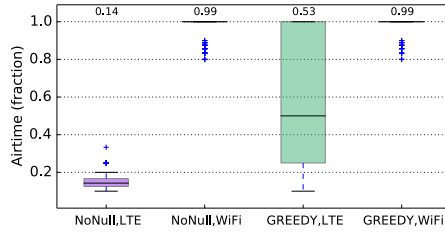

(a) Airtime.

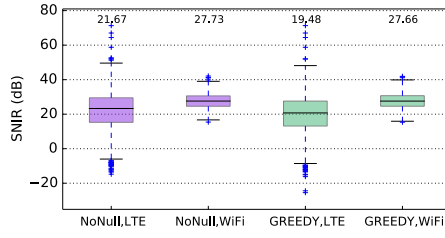

(b) SNR in dB.

Fig. 10. Airtime and average SNR under NoNull and GREEDY for $D = 30$ m and $K = 10$. Number above each box represents the mean value.

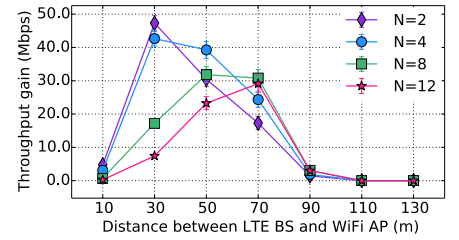

(a) LTE-U throughput gain.

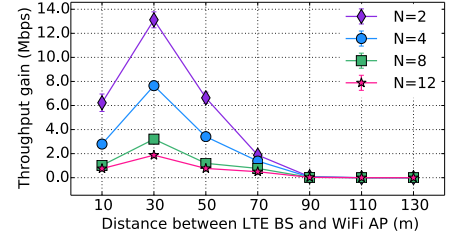

(b) WiFi throughput gain.

Fig. 11. Change in the throughput gain with increasing LTE-U and WiFi separation distance under various number of WiFi stations, $K = 6$.

domain. Our analysis on average number of nulled stations and AP (see [20]) show that nulling the AP is preferred only very rarely under higher N and short D .

On the other hand, with increasing D , the highest gain for LTE-U is achieved under higher N . For low N and high D , these few users might be far from the LTE-U BS resulting in a lower probability of interference with these stations. For higher N , the expected number of WiFi nodes in LTE-U's ED range is higher, resulting in a need for null steering.

Generally speaking, highest gain for WiFi is achieved when there is a few stations only. These stations will be receiving interference-free traffic mostly when LTE-U cell has sufficient antennas to null them. As we observe in Fig.11b, WiFi also has non-negative throughput gain under all cases, which proves our claim that our proposal is beyond coexistence; it provides benefits for the LTE-U and WiFi networks. Considering both Fig. 9 and Fig. 11, our experiments suggest that interference nulling provides the highest gains to both networks when their separation distance is moderate, e.g., distances where one network may be hidden to the other.

E. Discussions

One key consideration is transmission of uplink traffic from the WiFi stations. While uplink data traffic can be postponed to the LTE-U off-phase, control traffic must be carefully taken care of. For example, TCP ACK packets should be sent timely to avoid TCP misinterpreting the lack of acknowledgement. We believe that recommended short duration of on-periods, e.g., in the order of 20 msecs, avoids such undesirable impact. Furthermore, delayed TCP ACK mechanism used for decreasing ACK overhead can be enabled to postpone WiFi UL control traffic, e.g., current Linux IP stack uses this option and delays the ACKs by 40 msecs. Moreover, subframe punctures

every 20 msec are reserved for the purpose of latency-sensitive WiFi traffic. A WiFi AP can operate in Hybrid Coordination Function (HCF) mode and schedule the transmission of UL traffic during these subframe punctures to ensure that TCP acknowledgements are transmitted timely. On the MAC layer, delayed block ACKs allow us to postpone WiFi station ACKs.

We have not provided any analysis on the overhead of cooperation in our proposal. However, for quasi-static settings, e.g., indoor scenarios where WiFi users have mostly very low mobility, the entailed overhead will be very low. Moreover, LTE-U BS can implement some schemes to decrease this overhead, e.g., cache the WiFi information and estimate the locations of the nodes if provided some statistics, e.g., about node mobility. Finally, we considered single user MIMO to be used at the LTE-U BS. In case of multi-user MIMO, the sacrificed antenna diversity will be higher leading to a different trade-off function between airtime and best number of nulls. As a final note, we have discussed our proposal in the specific case of LTE-U but interference-nulling can also be exploited for Licensed-Assisted-Access (LAA) networks. In that case, we will have a different airtime vs. antenna diversity tradeoff as LAA does not implement CSAT but relies on LBT similar to WiFi.

VII. RELATED WORK

We classify the literature on noncoordinated coexistence solutions into two depending on where the coexistence solution is implemented: the LTE-U and the WiFi network.

Interference management in the LTE-U network: LTE-U manages its interference on neighboring WiFi networks by creating coexistence gaps in frequency, time, or space domain. *Coexistence gaps in frequency:* Similar to other spectrum sharing scenarios, frequency-domain sharing is the first step

in coexistence of LTE-U and WiFi. An LTE-U BS seeks for a clear channel to avoid impairing incumbent WiFi networks. In [8], a co-existence scheme is proposed that deals with the available channels of the unlicensed band as one pool. This means that the LTE-U will switch between various channels all the time to avoid the excessive use of one channel resulting in coexistence gaps in frequency domain.

Coexistence gaps in time: A simple coexistence scheme reuses the concept of almost blank subframes and subframe puncturing in LTE-U to create coexistence gaps in time domain [6], [7]. Works adapting LTE duty-cycle all are in this category.

Coexistence gaps in space: Coexistence can be achieved in space domain, e.g., changing the transmission power to adapt the interference region. Chaves et al. [9] proposed an LTE UL power control with an interference-aware power operating point which represents an alternative to the time-sharing approach for LTE-U/Wi-Fi coexistence. By a controlled decrease of LTE-U UEs' transmit powers, the interference caused to neighboring Wi-Fi nodes diminishes, thus creating WiFi transmission opportunities as WiFi nodes detect the channel as vacant. Our work falls into this category as we also create interference-free spaces in the WiFi cell. However, our proposal differs from existing works in many ways, e.g., it is coordinated coexistence exploiting the antenna resources of LTE-U BSs to achieve both gains at the LTE-U and the WiFi. The most relevant work to ours are [21] and [22] which propose interference nulling for LTE/WiFi coexistence. While [21] focuses on channel estimation and WiFi medium access under LTE interference, our paper addresses the tradeoff between airtime and data rate considering LTE-U's dynamic duty-cycling approach, i.e., CSAT, and we elaborate on how to choose WiFi nodes for interference nulling. While [22] proposes to schedule LTE UEs that are away from the WiFi nodes, we focus on which and how many of the WiFi nodes to be nulled under the given CSAT airtime fairness model.

Approaches which aim at increasing LTE-U airtime: There are also some approaches which apply a mixture of solutions with a goal to increase LTE-U's airtime. Power control is one way to decrease the interference range of the LTE-U BS and in return increase its duty cycle. Another approach proposed in [18] is to handover some of the WiFi users to the LTE-U cell so that LTE can gain some airtime by effectively using its spectral capacity to satisfy the transferred users' traffic requirements.

Interference management in the WiFi network: Although majority of the literature focuses on the LTE-U side, WiFi can also be equipped with mechanisms to be aware of neighboring LTE-U networks and strategize accordingly, e.g., move to another channel. The only work in this category is WiPLUS [5] which is a noncoordinated solution where interference mitigation is performed solely by the WiFi network via sophisticated NIC state analysis and mapping them to the LTE activity and hence being transparent to LTE-U.

VIII. CONCLUSIONS & FUTURE WORK

We have proposed a coordinated coexistence scheme for WiFi and LTE-U networks where LTE-U BSs equipped with multiple antennas create space-domain coexistence gaps via cross-technology interference nulling towards co-located WiFi nodes in the interference range. We provided algorithms to compute the WiFi nodes to be nulled. Simulation results reveal that proposed cooperation improves both the LTE-U and WiFi capacity and enables faster channel access. As future work, we plan to consider multiple antennas also at the WiFi AP.

ACKNOWLEDGMENT

The research leading to these results has received funding from the European Horizon 2020 Programme under grant agreement n688116 (eWINE project).

REFERENCES

- [1] Cisco, "The Cisco Visual Networking Index (VNI) Global Mobile Data Traffic Forecast Update," Tech. Rep., 2017.
- [2] "Making the best use of unlicensed spectrum for 1000x," White Paper, Qualcomm, 2015. [Online]. Available: <https://goo.gl/qvbGJf>
- [3] LTE-U Forum, "LTE-U Forum." [Online]. Available: <http://www.lteuforum.org>
- [4] N. Jindal, D. Breslin, and A. Norman, "LTE-U and Wi-Fi: A coexistence study by Google, Wi-Fi LTE-U coexistence test workshop," <https://goo.gl/x6r0Ac>, March 2015, online; accessed 30 Sept. 2017.
- [5] M. Olbrich et al., "WiPLUS: Towards LTE-U interference detection, assessment and mitigation in 802.11 networks," in *Euro. Wireless*, 2017.
- [6] E. Almeida et al., "Enabling LTE/WiFi coexistence by LTE blank subframe allocation," in *IEEE ICC*, 2013.
- [7] H. Zhang et al., "Coexistence of Wi-Fi and heterogeneous small cell networks sharing unlicensed spectrum," *IEEE Communications Magazine*, vol. 53, no. 3, pp. 158–164, 2015.
- [8] A. Al-Dulaimi et al., "5G communications race: Pursuit of more capacity triggers LTE in unlicensed band," *IEEE vehicular technology magazine*, vol. 10, no. 1, pp. 43–51, 2015.
- [9] F. S. Chaves et al., "LTE UL power control for the improvement of LTE/Wi-Fi coexistence," in *IEEE VTC Fall*, 2013.
- [10] P. Gawłowicz, A. Zubow, and A. Wolisz, "Enabling cross-technology comm. between LTE-unlicensed and WiFi," *IEEE INFOCOM*, 2018.
- [11] Qualcomm, "LTE-U Technology and Coexistence," <https://goo.gl/tZV9VG>, May 2015, online; accessed 29 Aug. 2017.
- [12] "LTE-U Technology and Coexistence," 2015. [Online]. Available: <http://www.lteuforum.org/workshop.html>
- [13] K. Aio et al., "Coexistence Analysis of ED Threshold Levels– Overview of Discussion in PDED Adhoc," March 2017.
- [14] WFA, "Wi-Fi Alliance Delivers LTE-U Coexistence Test Plan," <https://goo.gl/tsVqdA>, Sept. 2016, online; accessed 25 Sept. 2017.
- [15] K. C.-J. Lin, S. Gollakota, and D. Katabi, "Random access heterogeneous mimo networks," in *ACM SIGCOMM Computer Communication Review*, vol. 41, no. 4. ACM, 2011, pp. 146–157.
- [16] ITU-R, "IMT traffic estimates for the years 2020 to 2030," ITU, Tech. Rep. ITU-R M.2370-0, July 2015.
- [17] A. Zubow, P. Gawłowicz, and S. Bayhan, "XZero: On practical cross-technology interference-nulling for LTE-U/WiFi coexistence," *arXiv preprint arXiv:1801.07992*, 2018.
- [18] Q. Chen et al., "Rethinking mobile data offloading for LTE in unlicensed spectrum," *IEEE TWC*, vol. 15, no. 7, pp. 4987–5000, 2016.
- [19] H. L. Van Trees, *Optimum array processing: Part IV of detection, estimation and modulation theory*. Wiley Online Library, 2002, vol. 1.
- [20] S. Bayhan, A. Zubow, and A. Wolisz, "Coexistence Gaps in Space: Cross-Technology Interference-Nulling for Improving LTE-U/WiFi Coexistence," *ArXiv e-prints*, Oct. 2017.
- [21] S. Yun and L. Qiu, "Supporting WiFi and LTE co-existence," in *IEEE Conference of Computer Communications (INFOCOM)*, 2015.
- [22] G. Geraci et al., "Operating massive MIMO in unlicensed bands for enhanced coexistence and spatial reuse," *IEEE Journal on Selected Areas in Comms.*, vol. 35, no. 6, pp. 1282–1293, June 2017.