

Null-While-Talk: Interference Nulling for Improved Inter-Technology Coexistence in LTE-U and WiFi Networks

Suzan Bayhan*, Piotr Gawłowicz*, Anatolij Zubow*, and Adam Wolisz
Technische Universität Berlin, Germany
Email: {bayhan, gawlowicz, zubow, wolisz}@tkn.tu-berlin.de

Abstract—A recent proposal known as *unlicensed LTE* offers cost-effective capacity extension to the cellular network operators in which LTE operators bundle the unlicensed spectrum in 5 GHz UNII bands with their licensed spectrum via carrier aggregation. But, unlicensed spectrum requires coexistence among the networks operating in the same spectrum, e.g., IEEE 802.11 (WiFi) networks at 5 GHz. While WiFi implements Listen-Before-Talk (LBT) and is therefore coexistence-friendly, LTE-Unlicensed (LTE-U) lacks such capability as it is not designed with shared spectrum access in mind. Hence, LTE has a potential to seriously harm WiFi. Prior works suggest forcing LTE-U to separate its transmission in either frequency, time, or space, and without directly collaborating with the WiFi networks. Contrary to these schemes, we introduce an explicit cooperation between neighboring LTE-U and WiFi networks. We propose *Null-While-Talk* (NWT) which suggests that LTE-U BSs employ MIMO signal processing to create *coexistence gaps in space domain* in addition to the time domain gaps by means of cross-technology interference nulling towards WiFi nodes in the interference range. In return, LTE-U can increase its own airtime utilization while trading off slightly its gain from MIMO. First, we present simulation results indicating that such cooperation offers benefits to both networks, WiFi and LTE-U, in terms of improved throughput and decreased channel access delay. Moreover, we present Xzero which implements NWT in a practical setting where the LTE-U BS lacks channel state and location information about the WiFi stations to be nulled. Xzero overcomes this challenge by performing an intelligent null search guided by constant feedback from the WiFi node on the null directions being tested. Our Xzero prototype implemented on SDR and COTS WiFi hardware shows the feasibility of our proposal.

I. INTRODUCTION

Mobile networks seek increased network capacity to be able to provide their services with high user satisfaction to a constantly increasing number of users. While wireless local area networks (WiFi/IEEE 802.11) has been very instrumental to LTE operators by carrying a significant fraction of the offloaded mobile traffic (60% in 2015 [1]), LTE operators have recently started to explore the opportunity provided by carrier aggregation deep at the radio link level: licensed and unlicensed carriers are bundled for improved capacity. This new approach is referred to as *unlicensed LTE* and has two variants: LTE-unlicensed (LTE-U) and License-Assisted Access (LAA). To avoid major changes in the LTE, LTE-U does not require listen-before-talk (LBT) before medium

access and thereby can be deployed only in regions where LBT is not mandatory (e.g, US). In contrast, 3GPP-supported LAA mandates LBT property which can be implemented in various flavors and can be deployed worldwide [2], [3].

As LTE has higher spectral efficiency than WiFi, aggregation at this level has potential to expand the cellular capacity significantly as compared to WiFi offloading. Moreover, it enables efficient load balancing over the licensed and unlicensed channels as the LTE network has full awareness of the network load and signal quality of both links [4] and full control over the load shifting. But, LTE-U is expected to result in severe mutual interference to the co-located co-channel WiFi networks (e.g., [5], [6]), unless LTE-U networks implement coexistence solutions cautiously. The reason for mutual interference is due to the difference in the medium access ethics: WiFi is very agile in time domain owing to its LBT operation with a fine time granularity. This feature assures high efficiency in coexistence of WiFi deployments in proximity of each other. In contrast to WiFi, the LTE-U network relies on a predefined schedule determined by the LTE-BS scheduler, which can be changed only in a time scale in the order of tens of milliseconds, colliding with any other traffic in its activity phases.

Due to the importance of unlicensed LTE, there are plenty of proposals for LTE-U and WiFi coexistence, e.g., [7], [8], [9], [10], aiming at improvements of LTE-U coexistence-friendliness towards WiFi (i.e., achieving some airtime usage fairness) by adapting its operation parameters, e.g., reducing duty-cycle and introducing subframe puncturing, at the expense of LTE-U network's performance. Unfortunately, most of the proposals can only facilitate coexistence in long time scales and fail in assuring flexible coexistence in short term. In this paper, we propose to add *Null-While-Talk* (NWT) mechanism to LTE-U to compensate for its lack of LBT capability and introduce flexibility to the LTE-U in the space domain. More specifically, we suggest that LTE-U BSs equipped with an antenna array should exploit some of its antenna resources to perform interference-nulling towards co-located WiFi nodes. Then, LTE-U network can decrease the impact from its downlink (DL) traffic on these WiFi nodes. Consequently, LTE-U can increase its own airtime utilization as the nulled WiFi nodes can receive their DL traffic during LTE-U's on-period without distortion and hence need not to

*Equally contributed. An earlier version of this paper was presented at IEEE WoWMoM 2018.

be considered in airtime fairness considerations (as explained in Sec IV-C). In other words, an LTE-U BS can create coexistence gaps in space domain by interference nulling.

Contrary to the prior work which does not consider cooperation of two networks, our proposal suggests direct cooperation among WiFi and LTE-U networks, which is necessary for using the unlicensed bands with high efficiency rather than passively implementing coexistence solutions to decrease the impact of one network on the other. Hence, our proposal falls into the family of coordinated coexistence solutions [9].

Key contributions: First, we propose to apply interference-nulling at the LTE-U BSs equipped with multiple antennas towards co-located co-channel WiFi nodes as a way to create coexistence gaps in space. As a result, LTE-U/WiFi coexistence can be improved. We call this mechanism *Null-While-Talk (NWT)*. Second, we provide an optimization problem formulation to derive the optimal nulling configuration and also present a low-complexity heuristic for finding groups of WiFi nodes to be nulled. Simulation results reveal that interference-nulling can improve the throughput of the LTE-U cell up to 221% while also providing some gains for the WiFi, e.g., 44%. Moreover, both systems enjoy lower channel access delay which is of great importance for applications requiring low-latency communication. Third, we design Xzero which is an approach to realize NWT in a practical setting where LTE-U BS lacks some key information for interference-nulling. Rather than channel estimation as proposed in earlier work [11], we propose null beam search. Our approach is possible owing to the existence of a cross-technology communication channel, such as LtFi [12], between LTE-U and WiFi networks.

In this paper, we extend our earlier works [13], [14] to provide both theoretical and practical aspects of interference nulling for LTE-U/WiFi coexistence. Also, we present a more extensive analysis on NWT (e.g., impact of energy detection threshold, the number of nulled nodes, impact of sub-frame punctures on medium access delay) as well as an updated review of the state-of-the-art for LTE-U/WiFi coexistence.

II. BACKGROUND ON LTE-U, WiFi, AND INTERFERENCE NULLING

LTE-U: To realize unlicensed operation without major changes to the LTE design, an industry initiative LTE-U forum proposed an unlicensed LTE variant, known as LTE-U. LTE-U uses first as coexistence mechanism the dynamic channel selection (DCS) approach where the LTE-U BS seeks for a clear channel (coexistence gap in frequency domain). If all channels have some traffic (e.g., in dense urban deployments), LTE-U selects the channel with the least observed WiFi utilization and applies duty-cycling in this channel as a second coexistence mechanism. As LTE-U does not incorporate LBT mode into an LTE-U BS, it can be deployed only in countries where LBT is not mandated for unlicensed channel access, e.g., USA and China. LTE-U expands the DL capacity of an LTE network by carrier aggregation in which an LTE BS uses both the unlicensed band as a secondary cell in addition to the licensed anchor serving as the primary cell. The LTE-U

channel bandwidth is set to 20 MHz which is equal to the smallest channel width in WiFi.

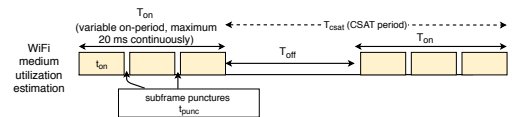

Fig. 1. Adaptive duty cycling in LTE-U. Duration of each period is shown in the corresponding period, i.e., subframe punctures (t_{punc}), contiguous on-periods within one LTE on-period (t_{on}), and off-period (T_{off}).

Fig. 1 shows the duty cycled unlicensed channel access of LTE-U. An LTE-U BS actively observes the channel for WiFi traffic and estimates channel activity for DCS and adaptive duty cycling. A mechanism called *carrier sense adaptive transmission (CSAT)* is used to adapt LTE-U's duty cycle [15], i.e., by modifying the on-period (T_{on}) and off-period (T_{off}) values, to achieve fair sharing. Moreover, LTE-U transmissions contain frequent gaps, so called *subframe punctures* with a duration denoted by t_{punc} , in the on-period, which allow WiFi to transmit delay-sensitive data. Qualcomm recommends 40, 80, or 160 ms as T_{CSAT} and $t_{punc} \geq 2$ ms every 20 ms. Please refer to [16] for an elaborate overview of unlicensed LTE networks. **WiFi:** In contrast to LTE-U which uses scheduled channel access, IEEE 802.11 WiFi nodes (APs and STAs) perform random channel access using an LBT scheme, i.e., CSMA. WiFi makes use of both virtual and physical carrier sensing. As WiFi cannot decode LTE-U packets due to the difference in their physical layer, it relies on physical carrier sensing (CS). Moreover, CS is restricted to Energy Detection (ED) which is less sensitive compared to preamble-based CS methods: ED threshold for sensing an LTE-U signal is -62 dBm whereas an AP can detect other WiFi signals at the sensitivity level around -82 dBm. ED threshold for LTE-U to sense WiFi signals takes various values in WiFi Alliance's Coexistence Test Plan including -82 dBm [17].

An LTE-U's transmission may have the following two impacts on WiFi depending on the received LTE-U signal's strength: (i) a WiFi transmitter defers access to the medium as the ED mechanism of WiFi is triggered upon a strong signal received from the LTE-U transmitter during the LTE-U on-periods; (ii) a WiFi receiver experiences frequent packet corruptions due to co-channel interference from the LTE-U transmitter. Case (i) results in lower airtime for WiFi due to channel contention while Case (ii) results in wasted airtime due to packet loss caused by inter-technology hidden node problem [5], [6].

Interference Nulling: A transmitter equipped with an antenna array, e.g., uniform linear array (ULA), can use precoding to change how its signal is received at a particular wireless node (Fig. 2). Hence, it multiplies the transmitted signal by a precoding matrix P . Specifically, in interference nulling the precoding matrix is chosen to null (i.e., cancel) the signal at a particular receiver, i.e. $HP = 0$, where H is the channel matrix from transmitter to receiver [18].

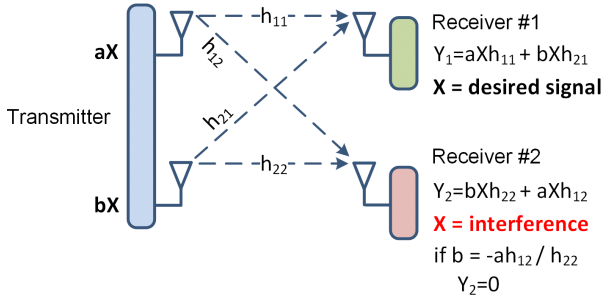

Fig. 2. To cancel out interference at receiver #2 the precoding must be $b = -ah_{12}/h_{22}$.

III. SYSTEM MODEL

Fig. 3 plots our system model wherein there is an LTE-U cell and WiFi Basic Service Set (BSS) with overlapping coverage and operating on the same unlicensed channel. The two cells (or more precisely the LTE-U BS and the WiFi AP) are separated by a distance of D meters. We denote the set of nodes in the LTE-U cell by $\mathcal{U}^l = \{u_0^l, u_1^l, \dots, u_M^l\}$ where u_0^l represents the LTE-U BS and the rest are UEs served by the LTE-U BS. Similarly, we denote the set of WiFi nodes by $\mathcal{U}^w = \{u_0^w, u_1^w, \dots, u_N^w\}$ where WiFi AP is represented by u_0^w and the rest stands for WiFi stations served by the WiFi AP. Let $d_{i,x}$ and $\theta_{i,x}$ denote the distance and angle of a user i (be it a UE or STA) from a BS x ($x = l$ for LTE-U or w for WiFi AP), respectively. We assume that LTE-U BS serves its UEs in different time slots, i.e. TDMA based scheduling. As for traffic, we assume full buffer traffic (similar to 100% load setting in [17]) for both networks and focus on the downlink (DL) only.¹

The distance D between LTE-U BS and WiFi AP along with the propagation environment (e.g., pathloss parameter γ) determines the operation regime of these two networks. If a WiFi AP detects the existence of an LTE-U BS in its neighborhood, i.e., the AP receives an LTE-U signal above ED threshold Γ_l dBm, then the WiFi network will access the medium only when the LTE network is idle. However, if the LTE's signal at the WiFi AP is weak (moderate D), the WiFi AP will transmit after channel sensing. In this case, the WiFi stations might experience high interference if they are closer to the LTE cell. The LTE BS might detect the existence of WiFi nodes (stations and the AP) if the received signal from a WiFi node is above Γ_w at the LTE BS. We denote the bandwidth of an unlicensed channel by B . Transmission power of LTE-U and WiFi is denoted by P_l and P_w . The distance-dependent pathloss parameter γ is assumed to be identical

¹For LTE-U system, this corresponds to supplementary DL case. For WiFi, our scenario is still relevant as current networks are DL-heavy, e.g., 80-90% [19] of data traffic is attributed to DL.

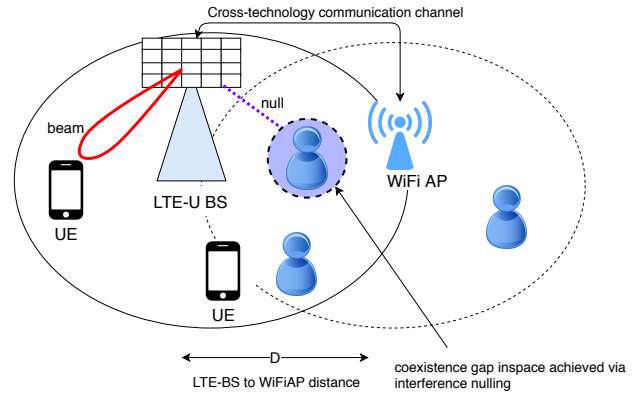

Fig. 3. Considered coordinated LTE-U and WiFi coexistence setting.

as both networks are deployed in the same environment and operate at the same frequency.

Consider an LTE BS equipped with an antenna array of K antennas (uniform linear array, ULA) whereas all its users and all WiFi nodes (i.e., AP as well) have only single antenna. Moreover, assume that the LTE BS is able to precode its DL signal for beamforming and interference-nulling toward its own UEs as well as a subset of the WiFi nodes to clear its interference on these users. We assume LTE-U BS and WiFi AP have a communication channel, e.g., LtFi [12] to exchange signalling and control data needed for interference nulling. To compute the precoding matrix for interference-nulling, the LTE-U BS requires knowledge of the channel matrix H towards the WiFi nodes (refer Section II). We assume that the LTE-U BS acquires the CSI H from the control channel. Later in Section V-C, we relax this assumption and explain how the LTE-U BS can still implement interference nulling without H . We denote the WiFi nodes being nulled by the LTE-U BS as \mathcal{U}_\emptyset^w and their number by K_\emptyset , i.e., $|\mathcal{U}_\emptyset^w| = K_\emptyset$. Denote the LTE-U BS's beam and nulling configuration $(\theta, \mathcal{U}_\emptyset^w)$ where θ is the angle between the LTE-U BS and its UE that is being served at this timeslot. Based on the used beamforming/nulling scheme, we can calculate the gain at each user. Denote the beamforming gain at the receiver under a configuration $(\theta, \mathcal{U}_\emptyset^w)$ by Φ and Φ_i is the gain at UE u_i . A WiFi station being nulled, e.g., u_i^w , will have a very small Φ_i value approaching to zero, i.e., an efficient nulling scheme results in very weak LTE-U signal at u_i^w . Table I lists the key variables.

IV. NULL-WHILE-TALK (NWT): OPTIMAL NULLING AND BEAMFORMING IN THE LTE-U DL

A. Overview of NWT

The motivation behind interference nulling is to increase concurrent transmission opportunities in a coexistence scenario rather than separating transmissions. In our setting, an LTE-U BS can transmit to its user while the WiFi AP transmits its DL to WiFi users who have almost zero interference from the LTE BS achieved by interference nulling in the direction of these WiFi users. Moreover, interference nulling

TABLE I
KEY VARIABLES

Variable	Explanation
Γ_l, Γ_w	Energy detection threshold for detecting LTE, WiFi signal
K	Number of LTE antennas
K_\emptyset	Number of LTE antennas used for interference nulling
N	Number of active WiFi users
N_{cs}	Number of active WiFi users in the LTE-U BS sensing range
Φ_i	Antenna gain at user i
σ_w	Whether WiFi AP senses the LTE-U network, i.e., $\{0,1\}$
σ_l	Whether LTE-U BS senses the WiFi network, i.e., $\{0,1\}$
α_l, α_w	Airtime of LTE and WiFi, respectively

has an impact on the LTE-U's airtime due to the CSAT airtime adaptation [15] (details in Sec.IV-C). In CSAT, LTE-U accounts for the number of WiFi nodes observed in its neighborhood to leave the airtime proportional to this number. As a result, LTE-U's airtime is lower in case of high number of WiFi nodes in the ED range of the LTE-U BS. Therefore, interference nulling decreases the number of WiFi nodes that will be affected by the interference of the LTE-U transmission, i.e., WiFi nodes in its ED range, and as a consequence, there is no need to consider such nodes in the estimation of the fair airtime share at the LTE-U BS. Moreover, since these nulled WiFi nodes are able to receive interference-free traffic during LTE-U's on-period, this approach promises benefits also to the WiFi network. On the other hand, longer airtime is achieved at the expense of reserving some of the LTE-U BS's antennas for nulling rather than using them for LTE-U's own DL transmission. In other words, some of the LTE-U BS's antenna diversity (aka degree of freedom) is sacrificed for longer airtime usage. Hence, LTE-U BS needs to apply nulling cautiously, i.e., we need to find the optimal operation point where both networks will be better off.

For a harmonious coexistence, an LTE-U BS should achieve a beamforming/nulling configuration such that both LTE-U and WiFi throughput are affected similarly, e.g., not disproportionate impact on WiFi's performance. In fact, our goal is to find the setting where both networks can benefit from our solution. Let us now list the key questions we will address in the rest of the paper: (i) How many of the degrees of freedom, i.e., antennas, an LTE-U BS should use for interference-nulling? (ii) Which of the co-located WiFi stations and/or the AP should be nulled? To address these questions, we first derive the trade-off between the additional airtime LTE-U gains from interference-nulling and the performance degradation in the LTE-U cell due to the loss of some degrees of freedom for its own DL. For the first question, we calculate the LTE-U throughput at its UE before and after nulling considering the LTE-U airtime and its SNR achieved at the scheduled UE. As for the second question, LTE-U considers the network geometry, e.g., distance of a WiFi node from the aggressor node and the serving node (i.e., LTE-U BS or WiFi AP, respectively).

As throughput is a function of the airtime available to a system and the average rate when the considered system captures the medium, we explain next how to calculate the

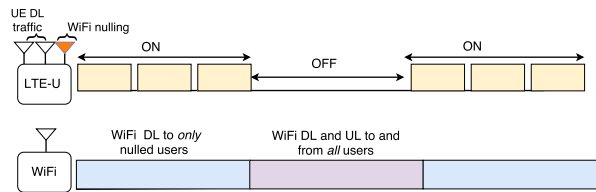

Fig. 4. Medium access of the LTE-U BS and WiFi nodes.

airtime and DL rate of LTE-U and WiFi systems under a particular beamforming/nulling configuration $(\theta, \mathcal{U}_\emptyset^w)$. Then, we formulate a sum-rate maximization problem subject to constraints of the nulling and WiFi/LTE-U coexistence setting.

B. Medium Access under NWT

Since NWT becomes more challenging when two networks are in a single collision domain, e.g., cells are separated with a short distance resulting in a strong signal at each other, we now focus on this case where the networks have to apply time sharing. Given that we consider only the DL traffic, the candidate transmitters are WiFi AP and LTE-U BS. In case LTE-U BS nulls the WiFi stations (receivers of WiFi DL traffic), it achieves a higher airtime resulting in lower airtime for the WiFi network. However, as WiFi AP defers during LTE-U on-periods, it cannot transmit to the nulled WiFi stations in the DL. Hence, if LTE-U nulls only the WiFi stations, the WiFi will not benefit from nulling. But, if LTE-U BS puts a null also in the direction of the WiFi AP, WiFi AP can always transmit and may achieve good channel rate at the nulled stations. Nulling only the WiFi stations can improve the WiFi performance in case the WiFi AP is sufficiently far away from the LTE-U BS such that it does not sense the LTE-U BS but WiFi stations are closer to the LTE-U BS. Hence, WiFi DL traffic will benefit from the absence of co-channel interference. Nulling is especially beneficial in case of cross-technology hidden-terminal problem where the WiFi AP can send DL traffic to the nulled stations during LTE-U's on-period without LTE interference.

Fig. 4 shows the medium access in these two considered cases. While WiFi transmission in both uplink (UL) and DL could be possible during the LTE-U on-period, it is impossible for LTE-U BS to predict which WiFi node will transmit due to the random access nature of WiFi. Hence, from a practical viewpoint, we need a solution where the nulling configuration does not depend on the WiFi traffic but rather only on the positions of the WiFi nodes. We suggest to focus on the WiFi DL which is meaningful as it represents the lion share of the traffic in the WiFi cell. Therefore, during the LTE-U's on-period, only WiFi DL traffic is considered and any WiFi UL traffic might experience high co-channel interference from LTE-U in case the WiFi AP is not nulled.²

²Note that high interference on the WiFi UL might lead to a problem for control frames like immediate ACKs. Enabling delayed block ACKs, which is an available option since IEEE 802.11n, can prevent such issues. These frames are sent via contention-based access and can be postponed to the off-period where all types of traffic is possible.

C. Airtime under NWT

To calculate airtime of the WiFi AP denoted by α_w and of the LTE-U BS denoted by α_l , we first check if the respective transmitter senses the other transmitter. Let σ_w represent whether WiFi AP receives the LTE-U BS signal above the predetermined ED level under a beam configuration Φ . We define σ_w as follows: $\sigma_w = 1$ if $\frac{P_l D^{-\gamma} \Phi_0}{B\eta_0} \geq \Gamma_l$ and it is zero, otherwise. The term Φ_0 shows the resulting LTE-U BS's antenna gain at the AP under Φ , i.e., precoding. In case $\sigma_w = 0$, WiFi's airtime is 1 meaning that the AP can always access the medium since it does not observe a strong signal in the channel. For $\sigma_w = 1$, since WiFi applies CSMA-based medium access, WiFi's airtime depends on the time the LTE-U does not use the medium, i.e., off-periods. Hence, we calculate LTE-U's airtime next. LTE-U applies CSAT as the main coexistence scheme. Based on the CSAT *on* and *off* periods, we can calculate the airtime for LTE-U simply as $\alpha_l = \frac{T_{on}}{T_{csat}}$ where $T_{csat} = T_{on} + T_{off}$ is the CSAT cycle set to a predefined recommended value, e.g., 80 ms [15]. While there are different suggestions to adapt the CSAT *on* duration (hence the T_{off} duration as $T_{csat} - T_{on}$), we will consider the approach in [15] which adapts T_{on} in several steps according to the medium utilization of WiFi.

Let us now overview the proposal in [15]. LTE-U small cells are scheduled to sense for WiFi packets during monitoring slots (in CSAT off-period) and estimate the medium utilization (MU) according to the decoded packet type and its duration. Given that off-period is sufficiently long, LTE-U cells may perform medium sensing several times and have a better observation about the ongoing WiFi traffic activity. In our model, we assume backlogged DL for both networks. Hence, WiFi's medium utilization converges to 1. An MU value higher than a threshold, e.g., MU_1 , triggers LTE-U BS to decrease its T_{on} as follows: $T_{on} = \max(T_{on} - \Delta T_{down}, T_{on,min})$, where T_{down} is the granularity of decrease at each adaptation step and $T_{on,min}$ is the minimum duration for on-period to ensure that LTE-U BS can transmit for some minimum duration. This minimum duration is computed according to the number of WiFi nodes being detected from the preambles of WiFi packets sensed by the LTE-U BS such that the airtime is *fairly* shared.

Let N_{cs} denote the number of WiFi nodes whose transmissions are sensed above the carrier sense threshold at the LTE-U BS. We can calculate N_{cs} as follows. With a slight abuse of the notation, we denote by $\sigma_{l,i}$ the flag taking value 1 if LTE-U BS senses WiFi user u_i^w . If $\frac{P_{w,i} d_{i,l}^{-\gamma}}{B\eta_0} \geq \Gamma_w$ then $\sigma_{l,i} = 1$ and zero, otherwise, where $P_{w,i}$ is the transmission power of u_i^w . Consequently, we compute N_{cs} as $\sum_{i=0}^N \sigma_{l,i}$. After calculating N_{cs} , LTE-U can compute $T_{on,min}$ as: $T_{on,min} = \min(T_{min}, \frac{(M_{same}+1)T_{csat}}{M_{same}+1+M_{other}+N_{cs}})$, where T_{min} is a configuration parameter tuning the minimum duty cycle below ED, M_{same} is the number of detected LTE-U small cells of the same operator, and M_{other} is the number of detected small cells of other operators. Note that LTE-U small cells belonging to the same operator have the same public land mobile network ID. Setting $M_{same} = 0$ and $M_{other} = 0$ in

the above $T_{on,min}$ formula, we calculate the second term of $T_{on,min}$ as $\frac{T_{csat}}{N_{cs}+1}$. As a smart decision from the perspective of LTE-U is to set T_{min} larger than $\frac{T_{csat}}{N_{cs}+1}$, we articulate that $T_{on,min}$ is determined by the second term of $T_{on,min}$: $T_{on,min} = \frac{T_{csat}}{N_{cs}+1}$.

At each iteration of CSAT adaptation, LTE-U BS will be forced to decrease its on duration by T_{down} since AP has always DL traffic, i.e., $MU \geq MU_1$. Consequently, T_{on} converges to $T_{on,min}$ which is calculated as $\frac{T_{csat}}{N_{cs}+1}$. Finally, we calculate the LTE-U airtime in case of no nulling as: $\alpha_l(K_{\emptyset} = 0) = \frac{T_{csat}}{T_{csat}} = \frac{1}{N_{cs}+1}$. If K_{\emptyset} users are nulled, the LTE-U airtime becomes: $\alpha_l(K_{\emptyset}) = \frac{1}{(N_{cs}-K_{\emptyset})+1}$. In the formula, nulled nodes are neglected while calculating the airtime as they will only marginally be affected by an LTE-U signal under an efficient null steering scheme. Therefore, they become irrelevant in fairness consideration.

Now, for $\sigma_w = 1$, we can calculate WiFi airtime based on whether LTE-U BS nulls the AP or not. In case WiFi AP is nulled, the WiFi airtime equals to 1. That is, interference nulling at the WiFi AP results in WiFi AP never defer as it will never sense an ongoing LTE-U transmission. If LTE-U does not prefer to null the AP, WiFi airtime is $\alpha_w = 1 - \alpha_l(K_{\emptyset})$. Table II summarizes airtime values based on carrier sensing condition of each network $CSR(\sigma_w, \sigma_l)$ where $\sigma_l = \{0, 1\}$ and $\sigma_w = \{0, 1\}$. As seen in Table II, LTE-U's airtime is independent of its σ_l value but instead depends on the number of WiFi nodes in the ED range of the LTE-U BS. For WiFi, we must consider σ_w as well as the nulling status of the AP.

Fig.5 plots the LTE-U airtime, i.e., $\alpha_l = \frac{T_{on}}{T_{csat}}$, for various number of neighboring WiFi nodes [15]. We find the change in LTE-U airtime at each CSAT adaptation step with increasing N_{cs} under the assumption that medium utilization is 1, i.e., WiFi traffic is backlogged. We set the initial values of $T_{on}=40$ ms, $T_{off}=40$ ms, $T_{csat}=80$ ms, $\Delta T_{down}=5$ ms. Moreover, we have set $T_{on,min}=80$ ms to let LTE-U be constrained by the WiFi traffic not artificially by its misconfiguration. Notice that the airtime values in Fig.5 converge to $\frac{1}{N_{cs}+1}$ after some adaptation steps as expected from our analysis. The convergence speed obviously depends on the initial value of T_{on} as well as T_{csat} , number of WiFi stations in the coexistence domain (N_{cs}) and how successfully LTE-U can detect their existence (MU and N_{cs}), and the granularity of decrease/increase steps (ΔT_{down} , ΔT_{up}). From Fig.5, we can also observe the nulling gain as the difference between the curves for two different N_{cs} curves. For example, for the initial setting of $N_{cs}=10$, we get the nulling gain in terms of airtime under $K_{\emptyset}=2$ as much as the difference of airtimes for $N_{cs}=8$ and that of $N_{cs}=10$, i.e., $1/9-1/11$. For lower N_{cs} , the benefit of nulling becomes more pronounced.

D. Throughput under NWT

For the LTE-U UE u_j^l , DL rate can be calculated as:

$$r_{j,l} = \begin{cases} r_{j,l}^0 = B \log\left(1 + \frac{P_l d_{j,l}^{-\gamma} \Phi_j}{B\eta_0}\right), & \text{blocked WiFi AP} \\ r_{j,l}^1 = B \log\left(1 + \frac{P_l d_{j,l}^{-\gamma} \Phi_j}{B\eta_0 + P_w d_{j,w}^{-\gamma}}\right), & \text{unblocked WiFi AP} \end{cases}$$

TABLE II

AIRTIME OF LTE-U AND WiFi FOR VARIOUS CSR(σ_w, σ_l) SCENARIOS: $\sigma_x = 1$ MEANS THAT NETWORK $X = \{l, w\}$ SENSES THE OTHER NETWORK ABOVE THE ED LEVEL. SHADED CELL SHOWS THE AIRTIME FOR WiFi WHEN NULLING IS NOT APPLIED.

Network	CSR(0,0)	CSR(0,1)	CSR(1,0)	CSR(1,1)		
				Null AP	Null K_\emptyset STAs	No Null
WiFi AP	1	1	$1 - \frac{1}{N_{cs} - K_\emptyset + 1}$	1	$1 - \frac{1}{N_{cs} - K_\emptyset + 1}$	$1 - \frac{1}{N_{cs} + 1}$
LTE-U BS	$\frac{1}{N_{cs} - K_\emptyset + 1}$					

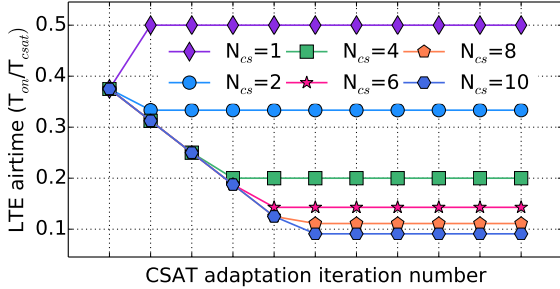
Fig. 5. LTE-U airtime for various N_{cs} .

where WiFi AP may be unblocked in two cases: (i) the AP does not sense LTE-U BS, i.e., $\sigma_w = 0$, or (ii) despite $\sigma_w = 1$, the AP can transmit because it is nulled. Note that in the above equation Φ_j is a function of the number of antennas used for nulling. The LTE-U BS uses its $(K - K_\emptyset)$ antennas for this UE resulting in lower beam gain if less antennas are available for the UE. As we already calculated the airtime for LTE, we can find the throughput for an LTE UE as: $R_{j,l} = \alpha_l r_{j,l}$.

As for WiFi DL rate, we must consider whether coexistence is only in the time or in both time and space domains. For the former, there will be no LTE-U BS interference on the WiFi DL. However, for the latter, as LTE-U BS changes state between on and off periods while WiFi AP has DL traffic, we calculate the WiFi DL rate at WiFi station u_i^w considering the rates during on and off periods. Consider the first case, i.e., $\sigma_w = 1$ and AP is not nulled. WiFi throughput $R_{i,w}^0$ is: $R_{i,w}^0 = (1 - \alpha_l)B \log(1 + \frac{P_w d_{i,w}^{-\gamma}}{B\eta_0})$. If sharing is in time and space, i.e., $\sigma_w = 0$ or AP is nulled, WiFi throughput $R_{i,w}^1$ equals to: $R_{i,w}^1 = \underbrace{\alpha_l B \log(1 + \frac{P_w d_{i,w}^{-\gamma}}{B\eta_0 + P_l d_{i,l}^{-\gamma} \Phi_i})}_{\text{LTE on-period}} + \underbrace{(1 - \alpha_l) B \log(1 + \frac{P_w d_{i,w}^{-\gamma}}{B\eta_0})}_{\text{LTE off-period}}$.

Note that Φ_i is marginal for $u_i^w \in \mathcal{U}_\emptyset^w$ and results in no rate degradation in the WiFi DL for u_i^w .

E. Channel access delay under NWT

We now calculate the expected time to access the medium for both LTE-U BS and the WiFi AP when CSR($\sigma_w = 1, \sigma_l = 1$). Considering the sub-frame punctures in Fig.1, there are three states that the LTE-U BS can be in: transmission state before going into sub-frame puncture periods, sub-frame punctures, and the off-period. Let us denote each state's probability

by $(p_{on}, p_{pun}, p_{off})$, respectively. Given expected channel access time in each state, we calculate the expected channel access delay as below: $\tau_l = p_{on} \cdot 0 + p_{pun} \frac{t_{pun}}{2} + p_{off} \frac{(1 - \alpha_l)T_{csat}}{2}$. Let $N_{pun} = \lfloor \alpha_l T_{csat} / (t_{on} + t_{pun}) \rfloor$ denote the number of sub-frame punctures, then the total duration of punctures equals to $N_{pun} t_{pun}$. Next, we calculate $p_{pun} = N_{pun} t_{pun} / T_{csat}$ and $p_{off} = (1 - \alpha_l)$ and plug these values into the above equation. Then, τ_l equals to:

$$\begin{aligned} \tau_l &= \frac{N_{pun} t_{pun}}{T_{csat}} \frac{t_{pun}}{2} + (1 - \alpha_l) \frac{(1 - \alpha_l) T_{csat}}{2} \\ &= \frac{N_{pun} t_{pun}^2}{2T_{csat}} + \frac{(1 - \alpha_l)^2 T_{csat}}{2}. \end{aligned} \quad (1)$$

To calculate τ_w , we need to consider the LTE's activity periods as the WiFi will be waiting for the medium in these periods.³ Generally speaking, the LTE transmits for a maximum $\min(\alpha_l T_{csat}, t_{on})$ of contiguous duration. However, the last activity period for $\alpha_l T_{csat} \geq t_{on}$ within an on-period may be shorter than t_{on} . For example, consider $t_{on} = 20$, $t_{pun} = 2$, and $T_{on} = 32$. Then, the LTE will transmit for 20 msec, will keep silent for 2 msec of a sub-frame puncture period, and finally will transmit only 10 msec before it goes into off-period. Hence, we calculate τ_w as follows:

$$\tau_w = \begin{cases} \frac{\alpha_l^2 T_{csat}}{2} & \text{if } \alpha_l T_{csat} < t_{on} \\ \frac{N_{pun} t_{on}^2}{2T_{csat}} + \frac{(\alpha_l T_{csat} - N_{pun}(t_{on} + t_{pun}))^2}{2T_{csat}} & \text{otherwise.} \end{cases} \quad (2)$$

where the first case represents short on-periods without sub-frame punctures and the second case considers the on-periods in the existence of sub-frame punctures. Notice that for the second case, setting $N_{pun} = 0$ gives us the first case without sub-frame punctures.

Fig.6 plots the channel access delays of LTE and WiFi transmitters with increasing LTE airtime α_l with and without sub-frame punctures and with the following parameters $T_{csat} = 80$, $t_{sub} = 2$, $t_{on} = 20$ msec. For LTE, the change in medium access delay is marginal. Therefore, we see an overlapping line for LTE. But, for WiFi, sub-frame puncturing introduces significant improvement in delay, i.e., shorter delays. Especially, this improvement is visible for high values of α_l . Under nulling, LTE-U BS experiences a faster access to the channel as LTE airtime α_l is increased. For WiFi, channel access delay gets shorter if AP is nulled: essentially we move from the regime of CSR(1,1) to that of CSR(0,1). As

³We ignore the backoff periods of the WiFi network in our calculations.

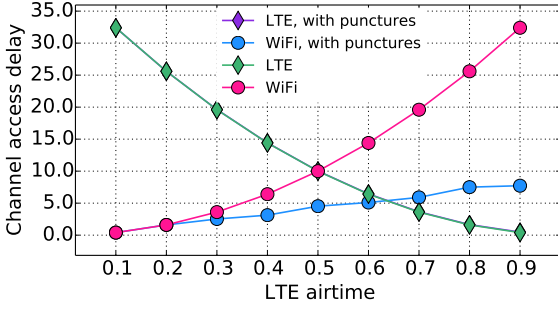

Fig. 6. Channel access delay for LTE and WiFi.

as a result, channel access delay becomes zero for the WiFi AP. But, when the AP is not nulled, WiFi cell might experience longer delay with longer LTE airtime.

F. Problem Formulation

We aim at finding the nulling configuration to be used at the LTE-U BS that provides the *optimal* performance. We consider several optimization objectives by changing the priority of LTE-U and WiFi denoted by β_l and β_w and satisfying the condition that $\beta_l + \beta_w = 1$. Our policies are: **MaxSum** maximizes the system wide capacity giving each system equal weight, i.e., $\beta_l = \beta_w$, with a constraint that WiFi capacity does not degrade compared to the baseline (referred to as NoNull) CSAT scheme. **MaxLTE** maximizes LTE-U capacity, i.e., $\beta_l=1$, $\beta_w=0$. **MaxWiFi** maximizes WiFi capacity, i.e., $\beta_w=1$, $\beta_l=0$. Let $\mathbf{x} = [x_i]$ be the LTE-U BS's nulling configuration where x_i yields value 1 if WiFi station i is nulled, 0 otherwise. Next, we formulate our problem as follows:

$$\max \quad \beta_w \frac{\sum_{i=1}^N R_{i,w}}{N} + \beta_l \alpha_l \sum_{j=1}^M r_{j,l} \quad (3)$$

$$R_{i,w} = \sigma_w ((1-x_0)R_{i,w}^0 + x_0 R_{i,w}^1) + (1-\sigma_w)R_{i,w}^1, \forall i \quad (4)$$

$$r_{j,l} = y_j (x_0 r_{j,l}^1 + (1-x_0)(\sigma_w r_{j,l}^0 + (1-\sigma_w)r_{j,l}^1)), \forall j \quad (5)$$

$$\sum_{j=1}^M y_j = 1 \quad (6)$$

$$x_i \leq \sigma_{l,i}, \quad \forall i = [0, N] \quad (7)$$

$$\sum_{i=0}^N x_i < K \quad (8)$$

$$\alpha_l = \frac{1}{\sum_{i=0}^N \sigma_{l,i} - \sum_{i=0}^N x_i + 1} \quad \text{and} \quad (9)$$

$$\alpha_w = x_0 + (1-x_0)(\sigma_w(1-\alpha_l) + (1-\sigma_w)) \quad (10)$$

$$x_i \in \{0, 1\} \quad \text{and} \quad y_j \in \{0, 1\} \quad \forall i = [1, N], \forall j = [1, M] \quad (11)$$

The first term of our objective (3) represents the expected DL throughput of the WiFi network weighted by β_w and the second term stands for the throughput of the LTE network weighted by β_l . Consts.(4) and (5) correspond to the throughput of a WiFi user and rate of an LTE-U user, respectively. Binary variable y_j in Const.(5) represents whether UE j is

scheduled to receive DL traffic. Const.(6) states the fact that there is only one UE actively receiving DL traffic from the LTE-U BS at any scheduling period. Since airtime increase is only relevant for nodes that are in the ED range of the LTE-U BS, we add Constr.(7) to ensure that x_i is zero if u_i^w is not in the range of LTE-U BS. Such WiFi nodes are not selected for nulling due to Const.(7). Const.(8) states that maximum number of nulled WiFi nodes must be smaller than the total number of LTE-U antennas so that at least one antenna is reserved for its UE. Consts.(10) define the airtimes of LTE-U and WiFi, respectively. Note that x_0 here stands for WiFi AP and states the fact that if WiFi AP is nulled, the airtime for WiFi will be 1. Finally, Consts.(11) denote the type of variables as binary integers. We assume that LTE-U BS first decides on which UE to serve and solve the above problem for $\mathbf{x}=[x_i]$ under a given $\mathbf{y}=[y_j]$. As solving for \mathbf{x} exactly is of high complexity, we present a low-complexity scheme next.

G. Low-Complexity Nulling: GREEDY

We propose a null grouping algorithm (GREEDY) that groups WiFi nodes into suitable subsets that are beneficial to null. GREEDY constructs a null group starting with the WiFi node that when being nulled gives the highest gain in terms of the selected metric, e.g., increase in LTE-U capacity, and sequentially extending this group by admitting the WiFi node providing the highest increase of a given grouping metric (refer to three policies in Section IV-F). Once the group reaches its target size or no more WiFi nodes can increase the grouping metric, the nulling group is considered complete. GREEDY needs following information: i) the set of WiFi nodes in the sensing range of the LTE-U BS, ii) the average pathloss of the channel from WiFi AP towards LTE-UE currently being served. The computational complexity considering execution time is $\mathcal{O}((N+1)^2)$ where $N+1$ represents the number of WiFi nodes—AP and STAs.

V. XZERO: A PRACTICAL CROSS-TECHNOLOGY INTERFERENCE NULLING SCHEME

Let us discuss how NWT can be implemented in a practical setting. First, the LTE-U BS needs the Channel State Information (CSI) and locations of WiFi stations to be able to implement the proposed Cross-technology Interference Nulling (CTIN) scheme. While our earlier work LtFi [12] enables cross-technology communication (CTC) between the two heterogeneous technologies, unfortunately, CSI cannot be obtained from the CTC. We have proposed Xzero [14] to overcome this challenge by applying a null beam search during the LTE-U on-periods. XZero performs a tree-based search and hence is able to quickly, e.g., in sub-seconds, find a proper precoding configuration used for interference nulling without having to search the whole angular space. Our prototype [20] shows the feasibility of Xzero. Below, we provide a brief overview of the design of Xzero.

A. Cross-technology Communication

In order to bring CTIN into practise, co-located LTE-U and WiFi networks need to setup a control channel to be used for

coordinating their activities. Recently, we proposed LtFi [12] which is a system enabling to set-up a cross-technology control channel (CTC) between adjacent LTE-U and WiFi networks for the purpose of cross-technology collaboration, e.g., radio resource and interference management. It is fully compliant with LTE-U technology, and works with WiFi commodity hardware by utilizing the spectrum scanning capability of modern WiFi NICs (e.g. Atheros 802.11n/ac). The LtFi architecture consists of two parts, namely an air and a wired interface. The former is used for over-the-air broadcast transmission of configuration parameters (i.e. public IP address) from LTE-U BSs to co-located WiFi APs which decode this information by utilizing their spectrum scanning capabilities. This configuration data is needed for the subsequent step to set-up a bi-directional control channel between the WiFi nodes and the corresponding LTE-U BSs over the wired backhaul, e.g. Internet. Note that a WiFi node, i.e., LtFi receiver, can measure on its air-interface the LTE-U signal's power for each WiFi OFDM subcarrier $|h_i|^2$ during both LTE-U's T_{on} and T_{off} phase. For the purpose of Xzero, we introduced new frame types in LtFi: power measurement and ii) null-beam search. The former is sent by the BS in preparation of the actual null-beam search to measure the power on each antenna path so that the precomputed precoding vectors can be corrected as in Sec. V-B. The null-beam search frame marks the start of the tree-based during which different null-beam configurations are tested.

B. Precoding Vectors and Power Correction

In Xzero, the LTE-U BS performs a tree-based null search to find the best nulling configuration while computing the precoding vector using LCMV beamformer [21] as it allows putting the signal in the desired direction (i.e., UE) and placing nulls into direction of WiFi nodes. The inputs to the LCMV are the direction of arrival angles. In Xzero, the precoding weight vectors $w \in \mathbb{C}^{1 \times K}$ are precomputed and stored in a tree data structure. During the null-search the tree is traversed.

In free space environment without multipath reflections, the so far described approach is able to find the correct nulling angle (for each LTE-U RB/SC), i.e., good INR values after nulling. However, this is not the case in a real environment with significant multipath resulting in frequency-selective fading. This is because so far we do not take the geometry of the environment into account. Hence, before performing the actual null-search, we measure the power on each antenna path independently. Therefore, the BS is transmitting its signal on each transmitter antenna alternately. The WiFi node to be nulled estimates the receive power $|h_s^k|^2$ of each antenna path k on each WiFi OFDM subcarrier s . This information is feedbacked to the LTE-U BS which is using it to correct the precoding values so that the power in each antenna path stays the same. However, the difference between the WiFi and LTE PHY layer, i.e., subcarrier and RB orientation, poses a challenge for Xzero in this step. In WiFi, each 20 MHz channel accommodates 64 subcarriers each with 312.5 kHz bandwidth whereas an LTE channel with 20 MHz bandwidth consists

of RBs with 180 kHz bandwidth and 15 kHz subcarriers. To have a mapping between the measured signal at the WiFi receiver and LTE transmitter RB, we find the subcarrier \hat{s} that has the closest central frequency to that of the LTE RB r , i.e., $\hat{s} = \arg \min_{s \in \text{NSC}} |f_c(r) - f_c(s)|$ where $f_c(\cdot)$ gives the center frequency of a WiFi subcarrier or RRB. Note that one could apply other methods for a more accurate estimation, e.g., extrapolation from 312.5 kHz to 180 kHz values. However, this aspect is out of scope for this paper. Let W denote the BS's actual precoding weight matrix: $W \in \mathbb{C}^{K \times \text{NRRB}}$, where NRRB is the total number of LTE RRBs. Then, we calculate the column r corresponding to RRB r of the corrected weight matrix as follows: $W_r = w \odot \left(\frac{|h_s^0|^2}{|h_s|^2} \right)^{\frac{1}{2}}$, where $s = \arg \min_{s \in \text{NSC}} |f_c(r) - f_c(s)|$ where w is the precomputed precoding vector (Sec. V-B) and \odot being the element-wise multiplication. In a final step, we normalize to ensure power after precoding sums up to the transmit power budget: $W_r^* = \frac{W_r}{\|W_r\|_F}$ where $\|\cdot\|_F$ denotes the Frobenius norm.

C. Standard Mode of Operation

Fig. 7 shows the standard operation of Xzero. The LTE-U and WiFi networks collaborate over the LtFi wired control channel. In case the decision was made to null the WiFi node, the power measurement phase starts at the end of which the BS knows the power on each antenna path and hence is able to correct the precomputed precoding values as described in Sec. V-B. Note that during that phase no precoding is applied. The subsequent step is a tree-based null beam search during which the LTE BS tests different nulling configurations⁴. WiFi AP feedbacks the ID of the configuration having the lowest interference-to-the-noise ratio (INR) value. The search stops after testing the single null configurations, i.e., leaves. Finally, from all tested nulling configurations, the LTE-U BS chooses the one achieving the lowest INR value.

D. Implementation Details

LTE-U BS: The LTE-U BS is based on Ubuntu 16.04 LTS using srsLTE [22], the open-source software-based LTE stack implementation, running on top of USRP software-defined radio platform, namely X310.⁵ In particular, we modified srsLTE to implement LTE-U's duty-cycled channel access scheme, where we provide an API to program the duration of T_{on} and T_{off} of single LTE-U period as well as the relative position of the puncturing during T_{on} phase. Also, the API allows setting the antenna precoding per RRB to be used during the LTE-U's T_{on} phase in real-time using UniFlex [23] control framework. We implemented LtFi and the actual functionality of Xzero, i.e., the tree-based null search, as Python-based applications.

WiFi AP: At the WiFi side, we use Ubuntu 16.04 LTS and commodity hardware, namely Atheros AR928X wireless NIC, that allows spectrum scanning at a very fine granularity.⁶ We

⁴A detailed description of the tree-based search can be found in [14].

⁵<https://kb.ettus.com/X300/X310>

⁶https://wireless.wiki.kernel.org/en/users/drivers/ath9k/spectral_scan

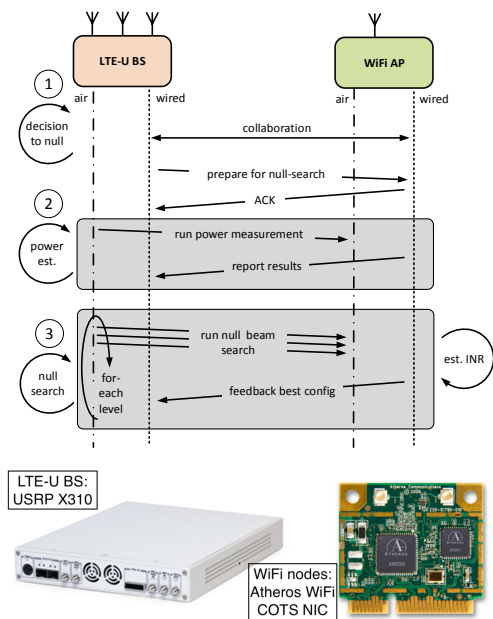

Fig. 7. The LTE-U and WiFi networks collaborate over the LtFi wired control channel. The process starts when the decision to null a particular WiFi node is made. Before the actual null-search, there is a phase where the receive power on each antenna path is measured. Prototype hardware: USRP X310 for LTE-U BS and Atheros WiFi COTS NIC for WiFi nodes.

sample with frequency of 5-50 kHz⁷ and pass this data to LtFi receiver component implemented in Python. Note that we disabled Atheros Adaptive Noise Immunity (ANI). The LtFi receiver component reports the INR values measured during the LTE-U's T_{on} and T_{off} phases to the Xzero component. From the set of measured INR values, the Xzero component estimates the nulling configuration with minimum INR which is sent to the Xzero component at the LTE-U BS through the wired LtFi interface. Finally, regarding the beamforming/nulling, no changes were needed on the WiFi as the interference nulling is fully transparent to the receiver.

VI. PERFORMANCE EVALUATION

We evaluate the performance of NWT by means of simulations using our custom-build Python simulator where we compute the antenna array response after precoding using Matlab's Phased Array system toolbox.⁸ Unless otherwise stated, we use the following parameters: number of UEs $M=1$, P_l and $P_w=17$ dBm as well as the power of WiFi stations while calculating N_{cs} , $\Gamma_w=-82$ dBm, $\Gamma_l=-72$ dBm. To determine the location of each user, we randomly select an angle in $[0, 2\pi]$ and distance in $[0, r]$ where r is set to 50 m for both LTE and WiFi. We change D in $[10\text{m}, 130\text{m}]$ with a step of 20 m to cover all interference regimes. Next, we present the average statistics and the standard error of the mean values of 500 runs. In addition to the simulation results, we also present results from the evaluation of the performance of the Xzero prototype in a large-scale testbed.

⁷We used the maximum sample rate which is a chipset-specific value.

⁸<https://de.mathworks.com/products/phased-array.html>

A. Gain from NWT

Fig. 8 compares NoNull with NWT under MaxSum policy for different distances between the LTE-U BS with six antennas ($K=6$) and WiFi AP with eight active users ($N=8$). We also find the optimal solution (OptMaxSum) maximizing the sum of LTE-U and WiFi throughput found through exhaustive search of all possible nulling groups considering the objective function in (3). As Fig. 8a depicts, LTE-U cell maintains higher throughput under nulling compared to NoNull. The throughput increase is mostly due to the increased LTE-U duty cycle because of nulling. The performance increase achieved by OptMaxSum is up to 152% for LTE which is realized at $D=50$ m. GREEDY achieves up to 92% improvement over NoNull and the highest gain is realized at $D=30$ m. The second observation is that the difference between GREEDY and OptMaxSum is mostly low with the exception at $D=50$ m. As of WiFi performance, we observe in Fig. 8b that WiFi cell slightly benefits from nulling. At $D=10$ m, the WiFi throughput is increased by 5% (and 1% by GREEDY) which corresponds to the highest gain for WiFi. However, for sparse user deployments, achieved throughput gain is higher. For example, for a WiFi cell with a single station (Fig.11), OptMaxSum provides 44% increase to the WiFi cell at $D=10$ m and 19% increase at $D=30$ while gain for GREEDY is 10% and 13%. For high distance, e.g., $D > 90$ m, there is no need for nulling as mutual interference diminishes.

B. Impact of optimization objective

Fig. 9 shows throughput performance of GREEDY under each nulling policy. We see that MaxSum offers a very good balance between LTE-U and WiFi performances: it achieves non-negative gains at each network while other two objectives might result in one network to suffer. Fig. 10 shows a similar trend considering the channel access delay of each network for LTE-U $T_{csat}=40$ ms. In Fig.10a, we also observe the reduction in the channel access latency at the LTE-U BS facilitated by NWT. For WiFi AP, channel access is faster than that of LTE-U BS due to longer airtime of the WiFi cell for this setting with $N=8$. Nevertheless, MaxWiFi can decrease it even further toward zero. However, we pick MaxSum as our policy for GREEDY in the following analysis.

C. Impact of number of LTE-U BS antennas

Fig. 12 shows the impact of the number of LTE BS antennas (K) when the neighboring WiFi cell has eight active WiFi users. Here, we present the absolute throughput gain of NWT over NoNull. Unsurprisingly, we observe in Fig. 12a that the LTE-U throughput can be increased significantly with larger K due to increasing MIMO implementation gain. This improvement is due to both increased beamforming gain and the possibility to steer multiple nulls. With increasing D , we first observe an increasing throughput gain. In this region, the increase in airtime due to more nulls outweighs the sacrificed antenna diversity at the LTE-U cell. As observed also in Fig. 12a, with further increase in distance, the need for interference nulling diminishes resulting in no throughput gain.

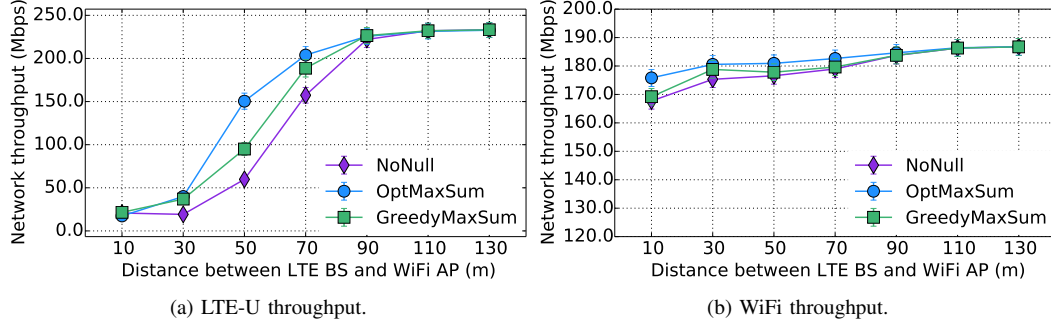

Fig. 8. Comparison of schemes for $K = 6$, $N = 8$.

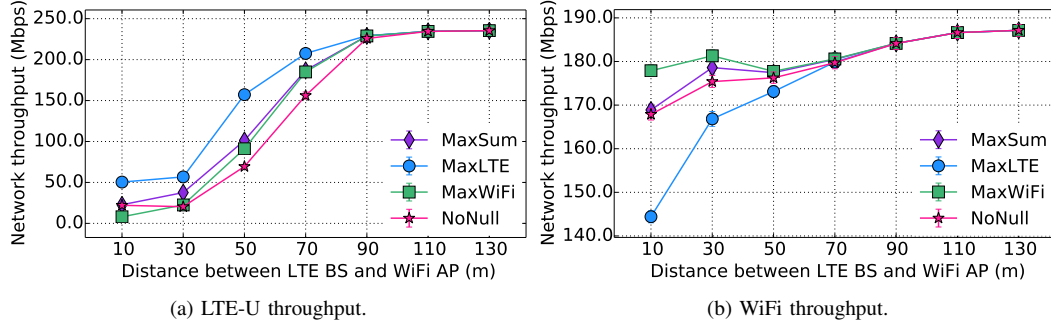

Fig. 9. Optimization objectives, $K = 6$, $N = 8$.

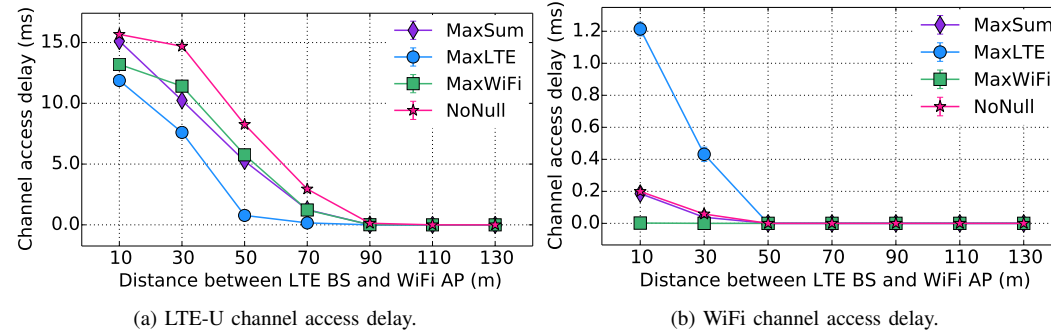

Fig. 10. Channel access delays, $K = 6$, $N = 8$.

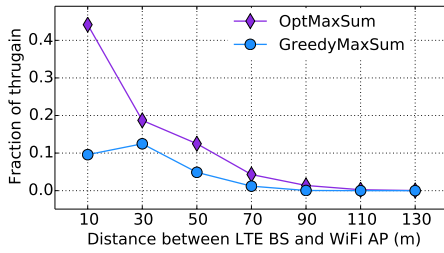

Fig. 11. Performance of WiFi in case of a single active WiFi user.

For $K=10$, achieved gains are (26%, 221%, 61%, 20%, 1%) for $D=(10, 30, 50, 70, 90)$ m. From WiFi's perspective, Fig. 12b depicts a similar trend. It has throughput gain in all cases for $D < 90$ m but the gain is markedly lower compared to the LTE-U's gain. In Fig. 13, we show for $D=30$ m the airtime and SNR under NoNull and GREEDY for both LTE and WiFi. The

figure shows that the airtime increase in LTE is very significant whereas there is also some decrease in the average SNR due to the loss in antenna diversity. On the contrary, WiFi experiences almost no change in its SNR and airtime.

D. Impact of number of WiFi users

Fig 14 shows the throughput gain of GREEDY over NoNull with $K=6$ antennas at the LTE-U BS for various number of users N and under increasing distance D . Regarding LTE-U cell, for short D , Fig. 14a shows that nulling brings higher throughput gain for N . In this region, WiFi AP senses the LTE-U BS. The only way to offer performance improvement also to the WiFi is to null the WiFi AP. However, WiFi stations, especially the ones in the near proximity of the LTE-U BS, must also be nulled to facilitate interference-free DL traffic at these stations. If LTE-U BS has enough antennas to null all the nearby stations, the WiFi network will boost its throughput as if there is no coexisting LTE-U network (as

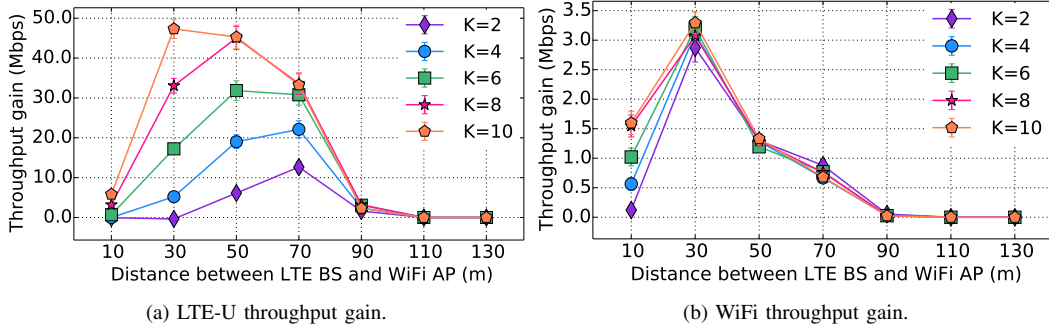

Fig. 12. Change in the throughput gain over NoNull under various LTE-U BS antenna settings, $N = 8$.

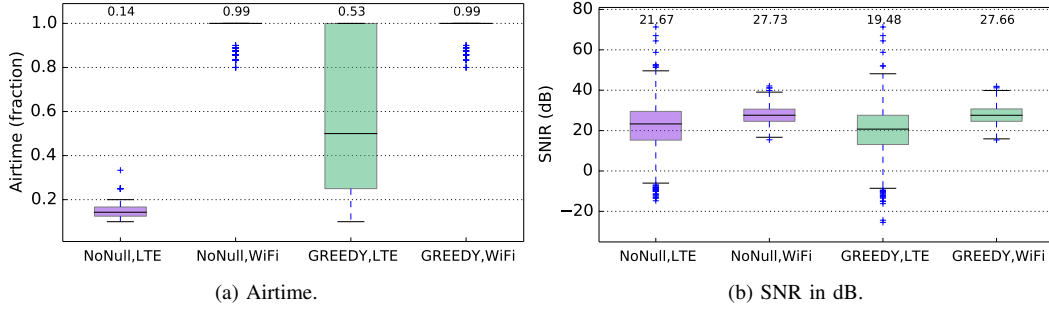

Fig. 13. Airtime and average SNR under NoNull and GREEDY for $D = 30$ m and $K = 10$. Number above each box represents the mean value.

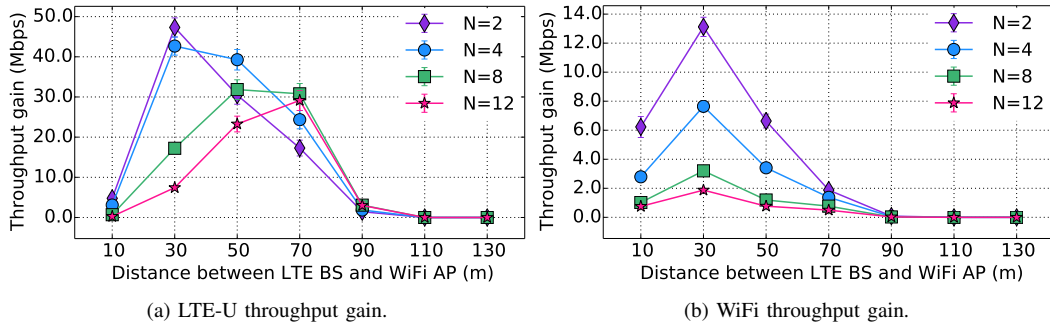

Fig. 14. Change in the throughput gain with increasing LTE-U and WiFi separation distance under various number of WiFi stations, $K = 6$.

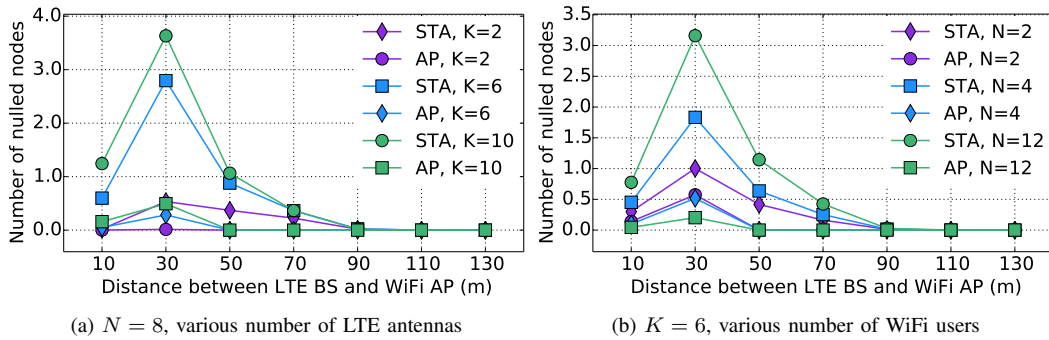

Fig. 15. Change in the number of nulled nodes with increasing distance.

observed in Fig.14b). Otherwise, i.e., case of many WiFi users, LTE-U may prefer putting coexistence gaps only in the time domain. Our analysis on average number of nulled stations and AP (see Fig.15) show that nulling the AP is preferred only very rarely under higher N and short D .

With increasing D , the highest gain for LTE-U is achieved

under higher N . For low N and high D , these few users might be far from the LTE-U BS resulting in a lower probability of interference with these stations. For higher N , the expected number of WiFi nodes in LTE-U's ED range is higher, resulting in a need for null steering. Generally speaking, highest gain for WiFi is achieved when there is a few stations only.

These stations will be receiving interference-free traffic mostly when LTE-U cell has sufficient antennas to null them. As we observe in Fig.14b, WiFi also has non-negative throughput gain under all cases, which proves our claim that our proposal is beyond coexistence; it provides benefits for the LTE-U and WiFi networks. Considering both Fig. 12 and Fig. 14, our experiments suggest that NWT provides the highest gains to both networks when their separation distance is moderate, e.g., distances where one network may be hidden to the other.

Inspired by the debates⁹ on Γ_l , we run our simulations under different Γ_l values. Fig.16 plots the change in LTE throughput gain under $\Gamma_l = \{-69, -72, -79\}$ dBm. As expected, under lower sensitivity (i.e., higher values of Γ_l), WiFi will access the medium longer as it may not sense the LTE. In this case, nulling brings slightly more benefits to the LTE as WiFi accesses the medium anyway. However, the behavior with increasing distance is the same across all Γ_l values, i.e. NWT is robust against different sensitivity values.

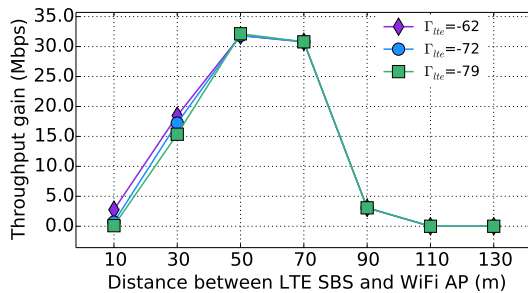

Fig. 16. Throughput gain of LTE network increasing distance under different Γ_l values, $N = 8$, $K = 6$.

E. Performance of Xzero: Selected Experimental Results

We evaluated the performance of Xzero by means of experiments in the ORBIT testbed [26]. As performance metric, we report INR at the WiFi node, with and without nulling. We calculate $INR = P_{T_{on}}/P_{T_{off}}$, where $P_{T_{on}}$ is the interference from the DL LTE-U signal during its on-phase and $P_{T_{off}}$ corresponds to the noise in the environment as no LTE signal is transmitted during the off-period. Subsequently, we calculate the interference reduction due to nulling as ΔINR .

The LTE-U BS's transmitter hardware used during this experiment is shown in Fig. 17. We selected $K=4$ transmit antennas arranged along a line (ULA) with spacing of 7.18 cm. The RF center frequency was selected as 2.412 GHz (WiFi channel 1 in ISM band) as the antenna spacing was fixed in the ORBIT grid and too large for 5 GHz UNII band.

For the experiment, we randomly selected 27 WiFi nodes equipped with Atheros 802.11n NIC from the ORBIT grid (*orbit-lab.org*). The placement of the BS and the location of the WiFi nodes are shown in Fig. 17. Next, we executed the two null search algorithms, namely Xzero's tree and linear search, and recorded the reduction in INR (ΔINR) due to nulling as compared to baseline without nulling. As Fig. 18

⁹Please see [24] and [25] for more discussion on various ED threshold values.

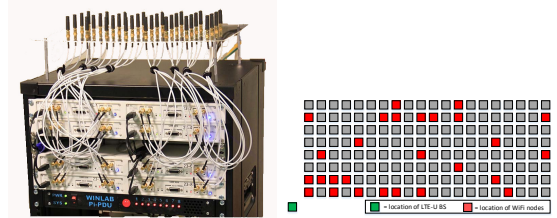

Fig. 17. Experiment setup in ORBIT grid network: mMIMO mini-rack used for Xzero transmitter (upper) and node placement in grid layout with ≈ 1 m spacing (lower).

shows, we observe significant reduction in INR for both schemes. More specifically, the average ΔINR for Xzero is 15.7dB while for some nodes the INR reduction can be up to 30dB. However, Xzero's tree-search achieves in general a slightly lower ΔINR compared to that of linear search. We attribute this difference to possible wrong decisions made during the tree search, i.e. wrong subtree traversed. However, the reconfiguration delay of Xzero is up to $10\times$ lower than that of the linear search [14]. This results in a tradeoff between null search speed and achieved ΔINR . Moreover, in a wireless environment with strong multipath, Xzero places multiple nulls even for single users as it chooses the best configuration from the tested nulling configurations. Hence, it is possible that in some situations, a nulling configuration from an inner node of the tree achieves better INR than those tested in the leaf nodes. In our experiment Xzero uses 2.7 nulls on average for a single user, i.e. WiFi node, to be nulled. Hence, we have a tradeoff between null-beam search speed and the required number of nulls.

VII. RELATED WORK

Interference management by the LTE-U network: LTE-U manages its interference on co-located WiFi networks by orthogonalizing (i.e., creating coexistence gaps) its transmission in one of the following domains: frequency, time, or space. (i) *Coexistence gaps in frequency:* Similar to other spectrum sharing scenarios, frequency-domain sharing is the first step in coexistence of LTE-U and WiFi. An LTE-U BS seeks for a clear channel to avoid channels with high network load from WiFi networks. Al-Dulaimi et al. [9] proposed a coexistence scheme where in order to avoid the excessive use of a single channel the LTE-U network performs slow frequency hopping over all available channels of the unlicensed band hence resulting in coexistence gaps in frequency domain. (ii) *Coexistence gaps in time:* In dense urban deployments, there is almost no clear channel. Hence, LTE-U has to share the spectrum with incumbent WiFi networks. Time-domain sharing represents the simplest co-existence scheme where LTE-U creates coexistence gaps in time domain by inserting either almost blank subframes or subframe puncturing [7], [8]. All work aiming to adapt the LTE duty-cycle fall into this category. (iii) *Coexistence gaps in space:* Finally, coexistence can be achieved in space domain by adapting the interference region through either changing the transmission power or by adapting the clear channel assessment threshold. Chaves

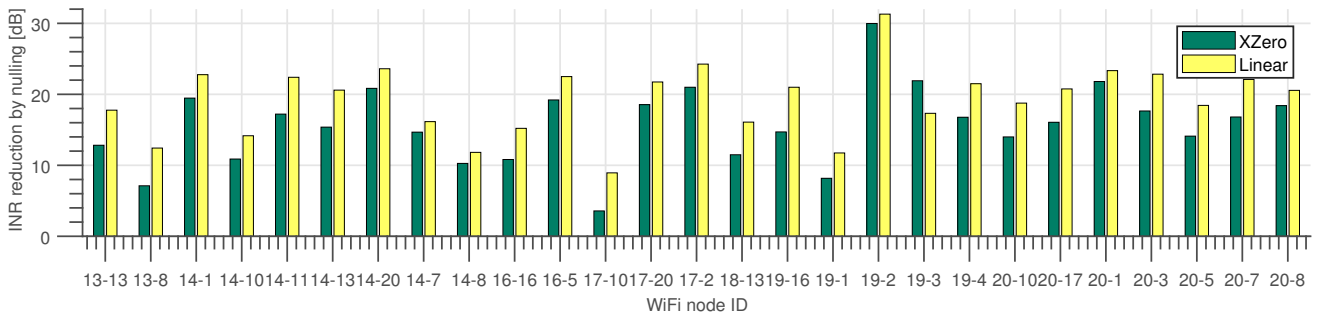

Fig. 18. Interference-to-noise ratio (INR) reduction after nulling for both XZero’s tree-search and linear search.

et al. [10] proposed an interference-aware adaptation of the transmission power used in the LTE uplink. By a controlled decrease of LTE-U UEs’ transmit powers, the interference caused to neighboring WiFi nodes can be reduced, thus allowing WiFi to transmit in parallel as the channel is detected vacant. Our work falls into this category as well. However, our approach has the following advantage. By employing MIMO signal processing, we are able to reduce just the power of the interfering signal while keeping the signal power of the wanted signal more or less the same. Simple transmission power control cannot achieve this as the power of the wanted signal is also reduced. The most relevant work to ours are [27] and [11] which propose interference nulling for LTE/WiFi coexistence. While [27] focuses on channel estimation and WiFi medium access under LTE interference, our paper addresses the tradeoff between airtime and data rate considering LTE-U’s dynamic duty-cycling approach and we elaborate on how to select WiFi nodes to be nulled. While [11] proposes to schedule LTE UEs that are away from the WiFi nodes, we focus on which and how many of the nodes to be nulled under the given CSAT airtime fairness model.

Interference management in the WiFi network: Although majority of literature focuses on the LTE-U side, WiFi can also implement CTIN in case the WiFi side is aware of neighboring LTE-U networks. Olbrich et al. [6] proposed WiPLUS which is a non-coordinated coexistence scheme where interference mitigation is performed solely on the WiFi network side. With WiPLUS a WiFi node is able to detect and quantify LTE-U activity on the channel. Moreover, synchronization information is provided so that in case of hidden terminals a cross-technology TDMA scheme can be applied, i.e. WiFi node is transmitting exclusively during the LTE-U off-phase. A similar functionality is provided by LTERadar in [28].

Practical interference-nulling: There are several practical solutions of employing MIMO signal processing for interference-nulling in inter-technology coexistence. TIMO [29] enables interference nulling at the WiFi transmitter and cross-technology decoding at the WiFi receiver to enable cross-technology coexistence with other unlicensed technologies like wireless baby monitors or cordless phones. To perform nulling, a WiFi transmitter requires CSI towards the co-located receiver of the other wireless technology which is obtained by utilizing channel reciprocity. To achieve ro-

business in channel estimation, TIMO samples the interferer’s signal for a few seconds, which makes it difficult to apply in mobile settings. To tackle the same challenge, Xzero performs a quick null search rather than trying to estimate the channel between LTE-U BS and WiFi node. Hence, Xzero can operate even under moderate node mobility. Furthermore, TIMO requires substantial changes at the WiFi receiver side and requires WiFi nodes to possess at least two antennas. Xzero and TIMO can complement each other: the former being implemented at the LTE-U BS and the latter at the WiFi AP. Yun et al. [27] were the first to present a practical approach considering cross-technology MIMO to support LTE/WiFi coexistence. Similar to [29], [27] proposes a decoding scheme where LTE and WiFi transmitters are active simultaneously and the receivers equipped with multiple antennas decode the overlapping transmissions. However, this work assumes the extreme case where LTE is transmitting continuously so that a special algorithm is needed to obtain the cross-technology channel state without the need to estimate a clean reference signal. This is not needed as LTE-U implements duty cycling. Moreover, [27] shares the same disadvantages with TIMO, e.g. modifications needed at LTE-UE and WiFi nodes for signal processing.

VIII. CONCLUSIONS

It is essential that operation of LTE-U does not threaten WiFi, which is by design coexistence-friendly owing to its LBT medium access scheme. To lift the coexistence capability of LTE-U, we proposed *Null-While-Talk* (NWT), which is a coordinated coexistence scheme for WiFi and LTE-U networks. In NWT, an LTE-U BS employs MIMO signal processing to create coexistence gaps in space via cross-technology interference nulling towards WiFi nodes in its interference range. As a result, both the LTE-U BS and the nulled WiFi nodes can simultaneously communicate without mutual interference. We proposed algorithms for the selection of WiFi nodes to be nulled. Simulation results reveal that NWT improves the capacity of both networks and reduces the channel access delay. Moreover, we presented XZero which is a practical, low-complexity solution for realizing NWT. XZero is able to quickly, e.g., in sub-seconds, find a proper MIMO precoding configuration used for interference nulling. Rather than an exhaustive linear null search in the whole angular space, XZero uses a tree-based search to find

proper beamforming configuration for nulling the selected WiFi nodes. We implemented a prototype of XZero using SDR for LTE and COTS for WiFi and evaluated its performance in a large indoor testbed. As future work, we plan to consider a setting where WiFi AP has also MIMO capability.

ACKNOWLEDGMENT

The research leading to these results has received funding from the European Horizon 2020 Programme under grant agreement n688116 (eWINE project).

REFERENCES

- [1] "The Cisco Visual Networking Index Global Mobile Data Traffic Forecast Update," Tech. Rep., March 2017.
- [2] "3GPP TR 36.889, 3rd Generation Partnership Project; Technical Specification Group Radio Access Network; Study on Licensed-Assisted Access to Unlicensed Spectrum," V13.0.0 (2015-6), Release 13," Tech. Rep., 2015.
- [3] G. J. Sutton, R. P. Liu, and Y. J. Guo, "Delay and reliability of load-based listen-before-talk in LAA," *IEEE Access*, vol. 6, pp. 6171–6182, 2018.
- [4] Qualcomm, "Making the best use of unlicensed spectrum for 1000x," White Paper, 2015.
- [5] N. Jindal, D. Breslin, and A. Norman, "LTE-U and Wi-Fi: A coexistence study by Google, Wi-Fi LTE-U coexistence test workshop," <https://goo.gl/x6r0Ac>, 2015, accessed 30 Oct. 2018.
- [6] M. Olbrich, A. Zubow, S. Zehl, and A. Wolisz, "WiPLUS: Towards LTE-U interference detection, assessment and mitigation in 802.11 networks," in *European Wireless*, 2017.
- [7] E. e. a. Almeida, "Enabling LTE/WiFi coexistence by LTE blank subframe allocation," in *IEEE ICC*, 2013.
- [8] H. Zhang, X. Chu, W. Guo, and S. Wang, "Coexistence of Wi-Fi and heterogeneous small cell networks sharing unlicensed spectrum," *IEEE Communications Magazine*, vol. 53, no. 3, pp. 158–164, 2015.
- [9] A. Al-Dulaimi, S. Al-Rubaye, Q. Ni, and E. Sousa, "5G communications race: Pursuit of more capacity triggers LTE in unlicensed band," *IEEE Vehicular Technology Magazine*, vol. 10, no. 1, pp. 43–51, 2015.
- [10] F. S. Chaves, E. P. Almeida, R. D. Vieira, A. M. Cavalcante, F. M. Abinader, S. Choudhury, and K. Doppler, "LTE UL power control for the improvement of LTE/Wi-Fi coexistence," in *IEEE VTC Fall*, 2013.
- [11] G. Geraci, A. Garcia-Rodriguez, D. López-Pérez, A. Bonfante, L. G. Giordano, and H. Claussen, "Operating massive MIMO in unlicensed bands for enhanced coexistence and spatial reuse," *IEEE JSAC*, 2017.
- [12] P. Gawłowicz, A. Zubow, and A. Wolisz, "Enabling Cross-technology Communication between LTE-U and WiFi," in *IEEE INFOCOM*, 2018.
- [13] S. Bayhan, A. Zubow, and A. Wolisz, "Coexistence Gaps in Space via Interference Nulling for LTE-U/WiFi Coexistence," in *IEEE WoWMoM*, 2018.
- [14] A. Zubow, P. Gawłowicz, and S. Bayhan, "On Practical Coexistence Gaps in Space for LTE-U/WiFi Coexistence," in *European Wireless*, 2018.
- [15] Jingyi Zhou and Mingxi Fan, IEEE Mentor, "LTE-U Forum and Coexistence Overview," <https://mentor.ieee.org/802.19/dcn/15/19-15-0057-00-0000-lte-u-forum-and-coexistence-overview.pdf>, July 2015, accessed Feb.5, 2019.
- [16] S. Zinno, G. D. Stasi, S. Avallone, and G. Ventre, "On a fair coexistence of LTE and Wi-Fi in the unlicensed spectrum: A survey," *Computer Communications*, vol. 115, pp. 35–50, 2018.
- [17] "Wi-Fi Alliance Delivers LTE-U Coexistence Test Plan," <https://goo.gl/tsVqdA>, accessed Feb. 2019.
- [18] K. Lin, S. Gollakota, and D. Katabi, "Random access heterogeneous MIMO networks," in *ACM SIGCOMM*, 2011.
- [19] ITU-R, "IMT traffic estimates for the years 2020 to 2030," ITU, Tech. Rep. ITU-R M.2370-0, July 2015.
- [20] P. Gawłowicz, A. Zubow, and S. Bayhan, "Cross-Technology Interference Nulling for Improved LTE-U/WiFi Coexistence," in *ACM MobiSys Demo*, 2018.
- [21] H. L. Van Trees, *Optimum array processing: Part IV of detection, estimation and modulation theory*, 2002.
- [22] I. Gomez-Miguel, A. Garcia-Saavedra, P. D. Sutton, P. Serrano, C. Cano, and D. J. Leith, "srsLTE: An Open-source Platform for LTE Evolution and Experimentation," in *ACM WiNTECH*, 2016.
- [23] P. Gawłowicz, A. Zubow, M. Chwalisz, and A. Wolisz, "UniFlex: A framework for simplifying wireless network control," in *IEEE ICC*, 2017.
- [24] K. Aio, R. Hirata, Y. Tanaka, and Y. Morioka, "Coexistence Analysis of ED Threshold Levels," <https://mentor.ieee.org/802.11/dcn/17/11-17-0348-00-0000-coexistence-analysis-of-ed-threshold.pptx>, March 2017.
- [25] M. Iqbal, C. Rochman, V. Sathya, and M. Ghosh, "Impact of changing energy detection thresholds on fair coexistence of Wi-Fi and LTE in the unlicensed spectrum," in *Wireless Telecommunications Symposium (WTS)*, April 2017.
- [26] "Open-Access Research Testbed for Next-Generation Wireless Networks (ORBIT)," <http://www.orbit-lab.org/>, online; accessed 01 February 2019.
- [27] S. Yun and L. Qiu, "Supporting WiFi and LTE co-existence," in *IEEE INFOCOM*, 2015.
- [28] C. Vlachou, I. Pefkianakis, and K.-H. Kim, "LTERadar: Towards LTE-Aware Wi-Fi Access Points," *Proceedings of the ACM on Measurement and Analysis of Computing Systems*, vol. 2, no. 2, pp. 33–64, 2018.
- [29] S. Gollakota, F. Adib, D. Katabi, and S. Seshan, "Clearing the RF smog: making 802.11n robust to cross-technology interference," in *ACM SIGCOMM*, 2011.